



**O**nline **d**ynamic **e**nterprise **S**olutions for **i**ndustry **e**xcellence



# 2020 Catalog of Web-based Training Modules

# odesie®

## 2020



**TECHNOLOGY TRANSFER SERVICES**

[www.myodesie.com](http://www.myodesie.com)

[www.techtransfer.com](http://www.techtransfer.com)

**14497 N. Dale Mabry Hwy Ste 120-N**

**Tampa, FL 33618**

**Phone: (813) 908-1100**

**Fax: (813) 908-1200**

<u>Series/Module Title</u>	<u>Page</u>	<u>Series/Module Title</u>	<u>Page</u>
<b>OSHA 10-HOUR GENERAL INDUSTRY PROGRAM</b> .....	<b>1</b>	<b>FOUNDATION SERIES</b> .....	<b>13</b>
<b>Mandatory</b> .....	<b>2</b>	<b>Overview of Industrial Facility Systems</b> .....	<b>14</b>
Intro to OSHA .....	2	Overview of Industrial Facility Systems .....	14
Walking and Working Surfaces .....	2	<b>Safety</b> .....	<b>15</b>
Fall Protection .....	3	Industrial Facility Safety .....	15
Exit Routes, Emergency Action, and Fire Prevention Plans .....	3	Fire Safety .....	15
Electrical Safety .....	4	Hazardous Communications .....	15
PPE .....	4	Lockout/Tagout .....	15
Hazardous Communications .....	4	Electrical Safety .....	16
<b>Elective</b> .....	<b>5</b>	Industrial Signage .....	16
Materials Handling .....	5	Personal Protective Equipment .....	16
Hazardous Materials .....	5	Benzene Awareness .....	16
Machine Guarding .....	6	First Aid I .....	17
Bloodborne Pathogens .....	6	First Aid II .....	17
Safety and Health Program .....	6	Hydrogen Sulfide .....	17
Fall Protection .....	7	<b>Mathematics</b> .....	<b>18</b>
Back Safety Ergonomics .....	7	Whole Numbers .....	18
<b>Optional</b> .....	<b>8</b>	Fractions .....	18
Environmental Awareness .....	8	Decimals and Percentages .....	18
Fall Protection .....	8	Exponents and Scientific .....	19
Fire Safety and Prevention .....	9	Notation .....	19
Industrial Signage .....	9	Fundamentals of Algebra I .....	19
Lockout/Tagout .....	9	Fundamentals of Algebra II .....	19
Crane Safety .....	9	Fundamentals of Geometry I .....	19
H2S Awareness .....	10	Fundamentals of Geometry II .....	19
Benzene Awareness .....	10	Fundamentals of Trigonometry .....	19
Industrial Facility Safety .....	10	Scientific Calculator Use .....	20
Spill Prevention, Control, and Countermeasures .....	10	Fundamentals of Statistics I .....	20
Asbestos .....	11	Fundamentals of Statistics II .....	20
GHS .....	11	Introduction to Calculus .....	20
HAZWOPER Awareness .....	11	<b>Tools</b> .....	<b>21</b>
Lead Overview for Base Construction .....	12	Hand Tools I .....	21
Lead Overview for General Industry .....	12	Hand Tools II .....	21
Toxic Substance Control Act .....	12	Power Tools .....	21

# Table of Contents

---

<u>Series/Module Title</u>	<u>Page</u>	<u>Series/Module Title</u>	<u>Page</u>
<b>Maintenance</b> .....	22	<b>AC Circuits</b> .....	33
Preventive Maintenance.....	22	AC Generation and Basic AC Concepts.....	33
Predictive Maintenance.....	22	Inductance, Capacitance, and Impedance.....	33
Basic Troubleshooting.....	22	Transformers.....	34
<b>Environment</b> .....	23	<b>Motors and Servos</b> .....	35
Environmental Awareness.....	23	AC and DC Motors.....	35
Hazardous Materials.....	23	Motor Control Fundamentals.....	35
<b>Computers</b> .....	24	Servo Drive Fundamentals.....	36
Computer Use Basics.....	24	<b>Semiconductors</b> .....	37
Computers in Industry.....	24	Diodes.....	37
<b>Print Reading</b> .....	25	Bipolar Transistors.....	37
Print Reading Basics.....	25	Other Semiconductors.....	38
Piping and Instrumentation Diagrams.....	25	<b>Power Supplies</b> .....	39
<b>Science</b> .....	26	Power Supplies.....	39
Introduction to Chemistry.....	26	Uninterruptible Power Supplies.....	39
Water Chemistry.....	26	Fuses.....	40
Applied Physics I: Work, Energy and Power.....	27	Circuit Breakers.....	40
Applied Physics II: Laws of Motion.....	27	<b>Digital Electronics</b> .....	41
Applied Physics III: Heat Transfer.....	27	Communication and Controls I.....	41
Applied Physics IV: Fluid Mechanics.....	27	Communication and Controls II.....	41
Applied Physics V: Ideal Gas Law.....	27	Introduction to PLCs.....	42
Applied Physics VI: Thermodynamics.....	27	Introduction to VFDs.....	42
<b>INDUSTRIAL ELECTRICITY AND ELECTRONICS</b> .....	<b>28</b>	Logic Gates and Number Systems.....	42
<b>Basic Electricity Principles</b> .....	29	<b>Work Practices</b> .....	43
Basic Electricity.....	29	Print Reading.....	43
Conductors and Insulators.....	29	Grounding Practices.....	43
Resistors.....	30	Test Equipment.....	44
Basic Laws of Electrical Circuits.....	30	Electrical Safe Work Practices.....	44
Electrical Power.....	30	Troubleshooting.....	44
Electromagnetism.....	30	<b>MECHANICAL</b> .....	<b>45</b>
<b>DC Circuits</b> .....	31	<b>Industrial Hydraulic Fundamentals</b> .....	46
Batteries.....	31	Hydraulic Theory.....	46
Series Circuits.....	31	Hydraulic Components I.....	46
Parallel Circuits.....	32	Hydraulic Components II.....	47
Series-Parallel Circuits.....	32	Hydraulic Systems.....	47
Switches and Relays.....	32		

<u>Series/Module Title</u>	<u>Page</u>	<u>Series/Module Title</u>	<u>Page</u>
<b>Industrial Pneumatics Fundamentals</b> .....	48	<b>Pipes and Pipefitting</b> .....	59
Pneumatic Theory I .....	48	Piping and Tubing .....	59
Pneumatic Theory II .....	48	Piping Materials and Manufacturing Methods.....	59
Pneumatic Components I .....	49	Pipe Insulation .....	60
Pneumatic Components II .....	49	Pipe Hangers and Supports .....	60
Pneumatic Systems .....	49	Codes and Standards .....	60
Air Compressor I.....	50	<b>Lubrication Concepts</b> .....	61
Air Compressor II.....	50	Principles of Lubrication .....	61
Air Compressor III.....	50	Preventing Wear and Erosion.....	61
<b>Precision Measuring Instruments</b> .....	51	Bearing System Lubrication .....	62
Precision Measuring Instruments .....	51	Lubricant Properties .....	62
Micrometers .....	51	Machinery Lubrication .....	62
Vernier Calipers.....	52	<b>Bearing Maintenance</b> .....	63
Dial Indicators .....	52	Bearing Fundamentals .....	63
Fixed Gauges.....	52	Rolling Contact Bearings I .....	63
<b>Pumps</b> .....	53	Rolling Contact Bearings II .....	64
Pump Design .....	53	Sliding Surface Bearings .....	64
Centrifugal Pumps.....	53	<b>Mechanical Transmission Systems</b> .....	65
Positive Displacement Pumps.....	54	Gear Drives.....	65
Special-Purpose Pumps.....	54	Gearbox Maintenance .....	65
Pump Maintenance.....	54	Belt Drives I .....	66
Mechanical Seals .....	54	Belt Drives II .....	66
<b>Static and Dynamic Sealing</b> .....	55	Belt Drives III .....	66
Packing .....	55	Belt Drives IV .....	66
Gaskets.....	55	Belt Drive Maintenance .....	66
Bolted Joints I .....	56	Chain Drives I .....	67
Bolted Joints II .....	56	Chain Drives II .....	67
Threaded Fasteners .....	56	<b>Rigging</b> .....	68
Torque and Tension .....	56	Basic Rigging I.....	68
<b>Valve Fundamentals</b> .....	57	Advanced Rigging I.....	68
Basic Types and Operations I .....	57	Advanced Rigging II.....	68
Basic Types and Operations II .....	57	<b>Shaft Alignment</b> .....	69
Basic Types and Operations III .....	58	Types and Effects of Shaft Misalignment.....	69
Relief and Safety Valves I .....	58	Alignment Tools and Methods.....	69
Relief and Safety Valves II .....	58	Soft Foot and Bar Sag.....	69
Actuators.....	58	Moving the Machine .....	70
		Rim and Face Alignment .....	70
		Cross and Reverse Dial Alignment.....	70

# Table of Contents

---

<u>Series/Module Title</u>	<u>Page</u>	<u>Series/Module Title</u>	<u>Page</u>
Laser Alignment .....	70	Control Valves I .....	81
<b>Welding Fundamentals</b> .....	71	Control Valves II .....	81
Introduction to Welding.....	71	Control Valves III .....	81
General Welding Safety .....	71	Control System Architecture.....	82
Shielded Metal Arc Welding.....	71	Limitorque Valve Actuator Fundamentals .....	82
Gas Tungsten Arc Welding.....	72	<b>Programmable Logic Controllers</b> .....	83
Gas Metal Arc Welding.....	72	PLC Overview.....	83
Oxyacetylene Welding and Cutting.....	72	PLC Communications .....	83
Brazing .....	72	PLC Software.....	84
Weld Joint Inspection .....	72	PLC Hardware .....	84
<b>Heat Exchangers</b> .....	73	PLC Addressing .....	84
Heat Exchangers I .....	73	<b>Process Analyzers</b> .....	85
Heat Exchangers II .....	73	Introduction to Process Analyzers.....	85
<b>INSTRUMENTATION AND CONTROLS</b> .....	<b>74</b>	Gas Chromatography I.....	85
<b>Intro to Instrumentation and Controls</b> .....	75	Gas Chromatography II.....	86
Industrial Instrumentation and Control Overview .....	75	Hydrogen Sulfide and Oxygen Analyzers .....	86
Principles of Measurement .....	76	Moisture Analyzers.....	86
Industrial Signal Standards .....	76	Density Analyzers .....	87
<b>Process Measurement</b> .....	77	Dew Point Analyzers .....	87
Pressure Measurement .....	77	Hydrogen Sulfide Gas Analyzers .....	87
Level Measurement .....	77	Introduction to Spectrometry .....	87
Introduction to Flow Measurement.....	77	Infrared Spectrometry .....	88
Head Flow Meters .....	78	Mass Spectrometry.....	88
Linear and Mass Flow .....	78	Process Analyzer Detectors.....	88
Temperature Measurement I .....	78	Residual Chlorine Analyzers.....	88
Temperature Measurement II .....	78	Turbidity Analyzers .....	88
<b>Process Controls and Monitoring</b> .....	79	UV-VIS Spectrometry.....	89
Process Control Fundamentals .....	79	pH Analyzers.....	89
Two-Position and Proportional-Control.....	79	Total Organic Carbon Analyzers .....	89
Integral, Derivative, and PID Control .....	80	Introduction to Chromatography .....	89
Loop Tuning.....	80	Titration Basics .....	90
Advanced Controls Methods.....	80	X-Ray Spectrometry.....	90
Intro to Actuators.....	80	<b>Distributed Control Systems (DCS)</b> .....	91
Actuator Principles of Operation .....	81	Data Acquisition and Control System Architecture .....	91
		Data Acquisition Communications Strategies.....	91
		Data Acquisition System Reliability .....	92
		Operator Interface Strategies.....	92

# Table of Contents

<u>Series/Module Title</u>	<u>Page</u>	<u>Series/Module Title</u>	<u>Page</u>
<b>ELECTRICAL</b> .....	<b>93</b>	Combustion Controls and Continuous Emissions Monitoring .....	104
<b>Circuit Protection</b> .....	94	Gas Turbine Lubricating and Lift Oil Systems .....	104
Basic Relaying I .....	94	Gas Turbine Hydraulic Oil Systems .....	104
Basic Relaying II .....	94	Fuel Support Systems.....	104
Advanced Circuit Breakers .....	94	Water Wash Systems.....	104
<b>Motors and Motor Control</b> .....	95	<b>Heat Recovery Steam Generators</b> .....	105
Alternating Current Motors .....	95	HRSG Basics .....	105
Motor Control Fundamentals .....	95	HRSG Drum and Blowdown Systems.....	105
Motor Protection and Nameplate Data.....	96	Duct Burners and Selective Catalytic Reduction Systems .....	106
Control Circuit Diagrams.....	96	Boiler Water Chemistry.....	106
Motor Starters .....	96	<b>Balance of Plant</b> .....	107
Direct Current Motors .....	96	Balance of Plant Basics.....	107
Electrical Diagrams .....	96	High-Pressure Steam Systems.....	107
<b>Transformers</b> .....	97	Reheat and Intermediate-Pressure Steam Systems .....	108
Transformers .....	97	Low-Pressure Steam Systems.....	108
Power Transformers I.....	97	Auxiliary Steam Systems .....	108
Power Transformers II.....	97	Condensers .....	108
<b>Variable Frequency Drives</b> .....	98	Steam Plant Water Systems.....	108
VFD Fundamentals.....	98	Cooling Water Systems.....	109
VFD Installation and Programming .....	98	Processed Water Systems.....	109
VFD Troubleshooting.....	98	Demineralized Water Systems .....	109
<b>POWER GENERATION</b> .....	<b>99</b>	Reverse Osmosis Water Systems .....	109
<b>Combined Cycle Fundamentals</b> .....	100	Wastewater Systems .....	109
Introduction to Power Plants .....	100	Compressed Gas Systems.....	110
Combined Cycle Plant Overview .....	100	Instrument/Service Air System .....	110
Combined Cycle Theory of Operations .....	101	Fire Protection Systems.....	110
Combined Cycle Major Components.....	101	<b>Steam Turbines</b> .....	111
<b>Gas Turbine</b> .....	102	Steam Turbine Basics.....	111
Gas Turbine Basics .....	102	Steam Turbine Bearings.....	111
Air Inlet Systems.....	102	Steam Turbine Hydraulic Oil Systems.....	111
Compressor Section.....	103	Steam Turbine Lubricating Oil Systems.....	112
Combustion Section.....	103	Gland Seal Steam Systems .....	112
Turbine Section .....	103	<b>Electrical Power Generation and Distribution</b> .....	113
Gas Turbine Bearings.....	103	Generator Basics .....	113
Starting Package .....	103	Generator Cooling Systems.....	113
Fuel Systems .....	103	Seal Oil Systems .....	114
		Switchyards and Power Distribution Lines .....	114

# Table of Contents

---

<u>Series/Module Title</u>	<u>Page</u>	<u>Series/Module Title</u>	<u>Page</u>
<b>Power Plant Efficiency</b> .....	115	Filtration II .....	126
Heat Rate Basics.....	115	Corrosion Control Treatment.....	126
Effect of Major Components on Heat Rate.....	115	Inorganics Removal .....	126
<b>Coal Plant Fundamentals</b> .....	116	Organics Removal.....	126
Power Plant Overview .....	116	<b>Wastewater Treatment</b> .....	127
Boiler Fundamentals.....	116	Introduction to Wastewater Treatment.....	127
Steam-Water Cycle.....	117	Disinfection and Chlorination.....	127
Boiler Water Chemistry Overview .....	117	Effluent Polishing.....	127
Flue Gas Systems.....	117	Chemical Feed Systems .....	128
Boiler Air Systems .....	117	Laboratory Overview .....	128
Combustion Basics .....	117	Odor Control .....	128
Fluidized Bed Combustion Boilers .....	117	Rotating Biological Contractors.....	128
Coal Handling and Preparation .....	118	Activated Sludge I .....	129
Steam Turbine Fundamentals.....	118	Activated Sludge II .....	129
Generator Fundamentals .....	118	Solids Handling and Disposal .....	129
Electrical Systems Fundamentals.....	118	Treatment Ponds and Lagoons.....	129
Instrumentation and Controls Fundamentals .....	118	Trickling Filters.....	130
<b>WATER AND WASTEWATER TREATMENT</b> .....	<b>119</b>	Wastewater Collection System.....	130
<b>Overview of Water Treatment</b> .....	120	Sampling .....	130
Overview of Water Treatment.....	120	Supplemental Removal .....	130
<b>Raw Water Treatment</b> .....	121	<b>MANAGER'S TOOLBOX</b> .....	<b>131</b>
Clarification .....	121	<b>Maintenance Management</b> .....	132
Disinfection.....	121	Introduction to Maintenance.....	132
Sedimentation.....	121	Condition-Based Maintenance.....	132
<b>Basic Water Purification</b> .....	122	Parts Management and Inventory Control .....	133
Media Filtration .....	122	Preservation .....	133
Ultra-Filtration.....	122	Preventive Maintenance Programs.....	133
Water Softening .....	122	Workflow and Controls .....	133
<b>Advanced Water Purification</b> .....	123	Procedure Writing Best Practices .....	133
Electrodeionization .....	123	<b>Organization-Based Maintenance</b> .....	134
Resin Bed Demineralizers .....	123	Overview of Reliability Centered Maintenance .....	134
Reverse Osmosis.....	124	Total Productive Maintenance .....	134
<b>Drinking Water Treatment</b> .....	125	Workplace Organization – 5S.....	134
Drinking Water Fundamentals .....	125	<b>Quality and Process Improvement</b> .....	135
Drinking Water Distribution Systems .....	125	Balanced Scorecard .....	135
Drinking Water Disinfection.....	125	Introduction to Six Sigma .....	135
Filtration I.....	126	Six Sigma – Introduction to DMAIC.....	135



<u>Series/Module Title</u>	<u>Page</u>	<u>Series/Module Title</u>	<u>Page</u>
Six Sigma – DMAIC Tools I.....	136	Boiler Operations .....	147
Six Sigma – DMAIC Tools II.....	136	Boiler Systems .....	147
Introduction to Lean.....	136	Boiler Blowdown .....	148
Statistical Process Control.....	136	Boiler System Controls .....	148
Total Quality Management .....	136	Boiler Management Control Systems .....	148
<b>Personal Effectiveness</b> .....	<b>137</b>	<b>General Inspections and Repairs</b> .....	<b>149</b>
Coaching.....	137	Cleaning Drains.....	149
Delegation .....	137	Faucet Repairs.....	149
Effective Listening in the Workplace.....	137	Pipe Repairs and Replacement .....	149
Effective Written Communications.....	138	Basic Masonry.....	150
Group Decision Making.....	138	Drywalls, Doors, and Locks .....	150
Basic Business Finance.....	138	HVAC Fundamentals.....	150
Project Management Fundamentals .....	138	Basic HVAC Maintenance .....	150
<b>Workforce Training</b> .....	<b>139</b>	Elevators I.....	151
ISD Overview.....	139	Elevators II.....	151
Training Analysis .....	139	Overhead Door Controls .....	151
Design of Effective Workplace Learning.....	140	Roofing, Walls and Balconies.....	151
Practical Training Development Methods.....	140	<b>Building Electrical Maintenance</b> .....	<b>152</b>
Implementation of Workplace Learning.....	140	Overview of Electrical Systems .....	152
Training Evaluation .....	141	Electrical Control Circuits .....	152
<b>Green Sustainability</b> .....	<b>142</b>	Electrical Tools and Test Equipment .....	153
Concepts in Green Purchasing.....	142	Electrical Distribution Components .....	153
Energy Ratings and Audits Defined.....	142	Receptacles and Lighting .....	153
Energy-Efficient Systems .....	142	<b>DISTRIBUTION AND WAREHOUSING</b> .....	<b>154</b>
Green Building Adding to the Bottom Line .....	143	<b>Basic Distribution and Warehousing</b> .....	<b>155</b>
Green Building and Renovations Defined .....	143	Distribution Center Overview.....	155
Green Certification and Standards .....	143	Conveyor Basics.....	155
<b>BUILDING MANAGEMENT AND MAINTENANCE</b> .....	<b>144</b>	Facility Maintenance.....	155
<b>Building Management Principles</b> .....	<b>145</b>	Fork Trucks I.....	156
Risk Management .....	145	Fork Trucks II.....	156
Preventive Maintenance.....	145	<b>Intermediate Distribution and Warehousing</b> .....	<b>157</b>
Cleaning Services.....	146	Battery Charging System I .....	157
Chemical Storage.....	146	Battery Charging System II .....	157
Facility Management.....	146	Photo-eye Installation .....	157
<b>Building Utilities and Boilers</b> .....	<b>147</b>	Pi-Touch.....	158
Combustion Fundamentals .....	147	Sorter Hardware.....	158
Boiler Types and Classifications.....	147	Sorter Operations.....	158

# Table of Contents

---

<u>Series/Module Title</u>	<u>Page</u>	<u>Series/Module Title</u>	<u>Page</u>
Switchgears .....	158	Bloodborne Pathogens .....	165
<b>Advanced Distribution and Warehousing</b> .....	<b>159</b>	Crane Safety .....	165
AGV Overview .....	159	Exit Routes, Emergency Action, and Fire Prevention Plans .....	165
AGV Operation .....	159	Fall Protection .....	166
AGV Preventive Maintenance .....	159	Machine Guarding .....	166
AGV Safety .....	160	Materials Handling .....	166
AKL Cranes .....	160	Safety and Health Programs .....	167
ASRS Cranes .....	160	Walking and Working Surfaces .....	167
Barcode Scanners .....	160	Asbestos .....	167
<b>SAFETY SERIES</b> .....	<b>161</b>	Back Safety Ergonomics .....	168
Industrial Facility Safety .....	161	GHS .....	168
Electrical Safety .....	161	Lead Overview for General Industry .....	168
Personal Protective Equipment .....	162	Lead Overview for Base Construction .....	168
Fire Safety .....	162	Toxic Substance Control Act .....	169
Industrial Signage .....	162	Worker Safety Documents and the Qualified Electrical Worker .....	169
Lockout/Tagout .....	162	Electrical Hazards and the Electrical Safety Program .....	169
Hazardous Communications .....	162	Electrical Work, Safe Work Area, and Other Precautions .....	169
Environmental Awareness .....	163	PPE Other Equipment and Shock Rescue .....	170
Hazardous Materials .....	163	Spill Prevention, Control, and Countermeasures .....	170
Benzene Awareness .....	163		
Hydrogen Sulfide Awareness .....	163		
Confined Space Entry Awareness Level .....	164		
HAZWOPER Awareness .....	164		
First Aid I .....	164		
First Aid II .....	164		

## OSHA 10-HOUR GENERAL INDUSTRY PROGRAM



The ***Occupational Safety and Health Administration***, or OSHA, regulates workplace safety by setting and enforcing standards and by providing training, outreach, education and assistance.

This OSHA series of modules explains varying OSHA mandates and standards. This series consists of 22 modules. Each module takes about 30 minutes to complete at an average pace.

## Mandatory

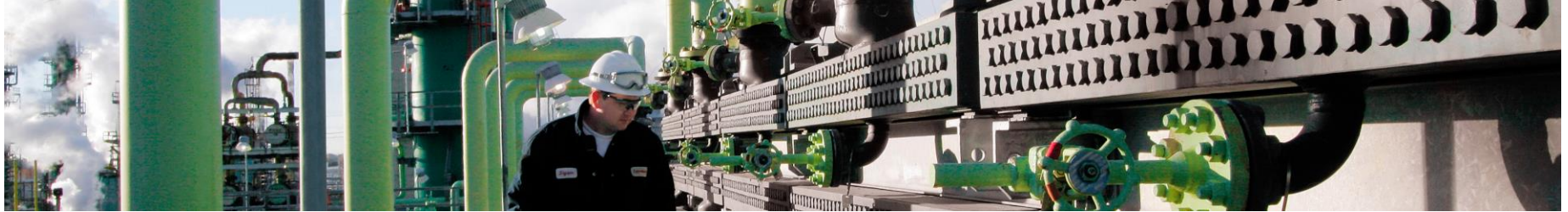

The *Mandatory* subject area in the OSHA series covers electrical safety, environmental awareness, fall protection, fire safety and prevention, industrial facility safety, industrial signage, lockout/tagout, PPE, and walking/working surfaces.



### **Intro to OSHA** Module #OSH0101

#### **Description**

OSHA is the *Occupational Safety and Health Administration*. It is the main federal agency charged with the enforcement of safety and health legislation. OSHA's mission is to "ensure safe and healthful working conditions for working men and women by setting and enforcing standards and by providing training, outreach, education, and assistance."

#### **Learning Objectives**

- Explain why OSHA is important to workers.
- Explain worker rights under OSHA.
- Discuss employer responsibilities under OSHA.
- Discuss the use of OSHA standards.
- Explain how OSHA inspections are conducted.
- Use helpful worker safety and health resources.

### **Walking and Working Surfaces** Module #OSH0102

#### **Description**

Slips, trips, and falls cause the majority of general industry accidents. 15% of all accidental deaths are caused by slips, trips, and falls. These cause more fatalities than any other accident except motor vehicles.

The OSHA standards for walking and working surfaces apply to all permanent places of employment, except where domestic, mining, or agricultural work is performed. Falls from as little as 4-6 feet can cause serious lost-time accidents and sometimes death. The OSHA standard identifies areas or activities where fall protection is needed. The standard clarifies how an employer must provide fall protection for employees, such as identifying and evaluating fall hazards and providing training. Under the standard, employers can select fall protection measures compatible with the type of work being performed.

The most cited areas of this module, *Walking and Working Surfaces*, are found in housekeeping requirements, and requirements for guarding floor openings and wall openings. Poor housekeeping and failure to properly guard wall and floor openings results in slips, trips, and falls.

**Learning Objectives**

- Explain the requirements for guarding floor openings and wall openings.
- Explain the requirements for guarding roof openings and skylights.
- Describe the requirements for stairways, ladder ways and railings.
- Follow recommended practices for using stairs and ladders.
- Follow recommended practices for using scaffolding and other working surfaces.

**Fall Protection**

**Module #OSH0103**

**Description**

Occupational fatalities caused by falls remain a serious public health problem throughout the United States. Data collected by the Bureau of Labor Statistics (BLS) Census of Fatal Occupational Injuries indicates that falls are one of the leading causes of traumatic death in the workplace, accounting for 13.7% of such deaths (808 of 5,900) in 2001. During that year, 23 workers died in falls through skylights, 11 died in falls through existing roof openings, and 24 died in falls through existing floor openings.

Data from the BLS Survey of Occupational Injuries and Illnesses shows that, during 1999, nearly 300,000 workers in private industry sustained injuries from falls, resulting in lost time from work. In 1999, an estimated 80 workers were injured in falls through skylights, 100 in falls through existing roof openings, and 617 in falls through existing floor openings. Most injuries occurred in construction, though many injuries occurred in other industries such as manufacturing, retail trade, and services.

OSHA emphasizes that workers remain at risk of falling through the floor, roof, skylight, and other openings. There is an increasing effort to identify fall hazards and implement prevention measures for reducing serious injuries and fatal falls.

**Learning Objectives**

- List the working conditions that prompt the use of fall protection.
- Describe the options that are available to protect workers from falls.
- List at least four methods of fall protection available for protecting workers.
- State the main criteria that prompts use of fall protection for construction workers.

**Exit Routes, Emergency Action, and Fire Prevention Plans**

**Module #OSH0104**

**Description**

There is a long and tragic history of workplace fires in this country caused by problems with fire exits and extinguishing systems. OSHA requires employers to provide proper exits, firefighting equipment, and employee training to prevent fire related deaths and injuries in the workplace.

Emphasis is on escaping from fires; however, some additional hazards include explosions, earthquakes, bomb threats, toxic vapors, and storms (tornadoes, hurricanes, etc.). Compounding factors that may interfere with a safe escape include panic and confusion, poor visibility, lack of information, and misinformation. These factors frequently cause more injuries and fatalities than the hazard itself.

**Learning Objectives**

- List or describe the three parts to an appropriate exit route.
- Discuss at least four characteristics of an effective exit route.
- Give four reasons for developing an emergency action plan.
- Name the required elements of a fire prevention plan.
- List the five classes of fire extinguishers and the types of fires they can properly extinguish.
- Describe at least four requirements for proper maintenance of portable fire extinguishers.

## Electrical Safety

Module #OSH0105

### Description

Roughly 20% of the electricity produced in the U.S. every year is used to power industrial facilities and equipment. While electricity makes it possible for these facilities to operate, it also poses a very real hazard, with several hundred electricity-related fatalities occurring at the workplace every year. To avoid or treat electrical shock, one must first understand it.

### Learning Objectives

- Define “electrical shock” and “arc flash.”
- Identify emergency response actions to take in the event of an electrical shock.
- Explain electrical safeguarding.
- Identify personal protective equipment required when working on energized electrical equipment.
- List the steps required to ensure electrical equipment is de-energized.



## PPE

Module #OSH0106

### Description

The *Occupational Safety and Health Administration*, or OSHA, mandates that it is an employer’s duty to provide a personal protective equipment, or PPE, program designed for their workplace. The employee must follow the PPE program and use the PPE required to conform to safe work practices for their particular job.

In 2003, the Bureau of Labor Statistics reported 4.4 million non-fatal injuries in private industries; this emphasizes the importance of safety in the workplace.

### Learning Objectives

- Describe personal responsibilities regarding personal protective equipment.
- List the personal protective equipment that is commonly associated with industrial sites.
- Describe the proper care, use, and inspection of personal protective equipment.
- Explain the effects of using defective or incorrect personal protective equipment.

## Hazardous Communications

Module #OSH0107

### Description

This module gives an overview on how an effective hazardous communication program can prevent injuries in a work environment.

### Learning Objectives

- Explain the importance of hazardous communication.
- Describe the labeling requirements for hazardous communication, including material safety data sheets.
- Discuss the proper use of hazardous communication programs.

## Elective



The *Elective* subject area in the OSHA series covers blood borne pathogens, materials handling, and safety and health programs.

### Materials Handling

#### Module #OSH0201

##### Description

The efficient handling and storing of materials is vital to industry. These operations provide continuous flow of raw materials, parts, and assemblies through the workplace, and ensure that materials are available when needed. Yet, the improper handling and storing of materials can cause costly injuries.

Some of the most common causes of material handling injuries are:

- Improper manual lifting or carrying loads that are too large or heavy.
- Being struck by materials or being caught in pinch points.
- Crushed by machines, falling materials or improperly stored materials.
- Incorrectly cutting ties or securing devices.

##### Learning Objectives

- List the three main injuries that occur during material handling, storage, use, and disposal.
- Describe at least two ways to prevent injury when performing manual lifting.
- Identify the hazards involved in mechanical material handling.
- Describe the training required in materials handling.
- Describe at least three actions that can reduce or eliminate hazards when storing or disposing of materials.

### Hazardous Materials

#### Module #OSH0202

##### Description

In *Hazardous Materials*, you will learn to identify common hazardous materials, describe hazardous material handling and disposal procedures, and discuss hazardous material safety precautions and regulations.

##### Learning Objectives

- Identify common hazardous materials.
- Describe handling and disposal procedures.
- Discuss safety precautions and regulations.

## Machine Guarding

Module #OSH0203

### Description

Crushed hands and arms, severed fingers, blindness—the list of possible machinery-related injuries is as long as it is horrifying. Safeguards are essential for protecting workers from needless and preventable injuries.

A good rule to remember is: Any machine part, function, or process that may cause injury must be safeguarded.

Where the operation of a machine can injure the operator or other workers, the hazard must be controlled or eliminated.

### Learning Objectives

- Describe at least two of the main causes of machine accidents.
- List three of the requirements for safeguards.
- List five machinery parts that pose hazards when unguarded or improperly guarded.
- List at least five types of machine guards.
- List at least three types of devices used to safeguard machines.
- Describe a situation that warrants machine guarding and an appropriate method of guarding the machine or part to prevent injury or accident.

## Bloodborne Pathogens

Module #OSH0204

### Description

“Bloodborne pathogens” means pathogenic microorganisms that are present in human blood and can cause disease. These pathogens include, but are not limited to, hepatitis B virus (HBV), which causes hepatitis B, hepatitis C virus (HCV), which causes hepatitis C, human immunodeficiency virus (HIV), which causes AIDS, and other pathogens, such as those that cause malaria.

About 5.6 million workers in healthcare and other facilities are at risk of exposure to bloodborne pathogens such as HBV, HCV, and HIV. Bloodborne pathogen exposure may occur in many ways, but needlestick injuries are the most common cause. Exposure may also occur through contact of contaminants with the nose, mouth, eyes, or skin.

### Learning Objectives

- Give at least three examples of workers who are at risk of exposure to bloodborne pathogens.
- List the three ways exposure to bloodborne pathogens commonly occur.
- Describe at least five key aspects of a Bloodborne Pathogen Exposure Control Plan.
- Explain how properly used PPE and housekeeping methods protect against exposure to bloodborne pathogens.
- List three important steps to take if exposed to a bloodborne pathogen.

## Safety and Health Program

Module #OSH0205

### Description

Effective management of worker safety and health protection is a decisive factor in reducing the extent and the severity of work-related injuries and illnesses. A good safety and health program addresses all work-related hazards, including those potential hazards that could result from a change in worksite conditions or practices.

OSHA’s experience in the Voluntary Protection Program has also indicated that effective management of safety and health protection improves employee morale and productivity, as well as significantly reducing Workers’ Compensation costs and other less obvious costs of work-related injuries and illnesses.

### Learning Objectives

- Discuss the benefits of an effective safety and health program.
- List the four elements of an effective safety and health program.
- Describe the three methods to prevent and control workplace hazards.
- Describe worksite analysis.
- List safety and health training needs.



## Fall Protection

### Module #OSH0206

#### Description

Occupational fatalities caused by falls remain a serious public health problem throughout the United States. Data collected by the Bureau of Labor Statistics (BLS) Census of Fatal Occupational Injuries indicates that falls are one of the leading causes of traumatic death in the workplace, accounting for 13.7% of such deaths (808 of 5,900) in 2001. During that year, 23 workers died in falls through skylights, 11 died in falls through existing roof openings, and 24 died in falls through existing floor openings.

Data from the BLS Survey of Occupational Injuries and Illnesses shows that, during 1999, nearly 300,000 workers in private industry sustained injuries from falls, resulting in lost time from work. In 1999, an estimated 80 workers were injured in falls through skylights, 100 in falls through existing roof openings, and 617 in falls through existing floor openings. Most injuries occurred in construction, though many injuries occurred in other industries such as manufacturing, retail trade, and services.

OSHA emphasizes that workers remain at risk of falling through the floor, roof, skylight, and other openings. There is an increasing effort to identify fall hazards and implement prevention measures for reducing serious injuries and fatal falls.

#### Learning Objectives

- Identify the working conditions that prompt the use of fall protection.
- Describe the options that are available to protect workers from falls.
- List at least four methods of fall protection available for protecting workers.
- State the main criteria that prompts use of fall protection for construction workers.

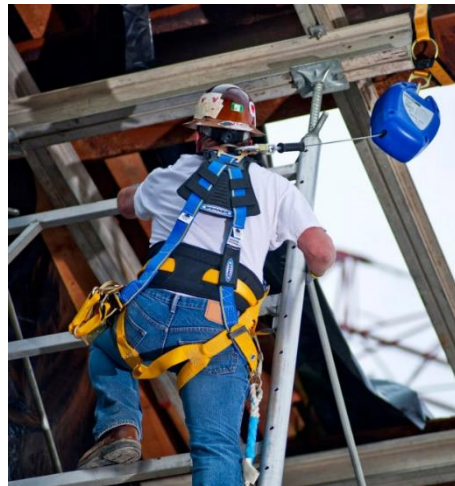

## Back Safety Ergonomics

### Course #OSH0207

#### Description

Although back injuries account for no work-related deaths, they do account for a significant amount of human suffering, loss of productivity, and economic burden on compensation systems. Back disorders are one of the leading causes of disability for people in their working years and afflict over 600,000 employees each year. The frequency and economic impact of back injuries and disorders on the workforce are expected to increase over the next several decades as the average age of the workforce increases and medical costs go up.

#### Learning Objectives

- Explain the importance of back safety.
- Describe how to prevent injuries and reporting requirements in the workplace.
- Identify ergonomic issues in the workplace.
- Understand the ergonomic solutions to control hazards.
- Explain the importance of ergonomics training and enforcement.

### Optional



The *Optional* subject area in the OSHA series covers Benzene awareness, crane safety, and hydrogen sulfide awareness.

### Environmental Awareness

#### Module #OSH0112

##### Description

Since the Industrial Revolution in the last century, the public has become more concerned about preserving the environment and exploring the benefits of sustainability. Environmental awareness has had a major impact on industry worldwide. It has led to greater scrutiny of all industrial processes because they contribute the largest amount of environmental pollution. The U.S. Environmental Protection Agency, or EPA, reported in its *Toxics Release Inventory*, or TRI, that industrial facilities release more than 6.5 billion pounds of toxic chemicals into the environment each year. Of these 6.5 billion pounds, 100 million pounds contain cancer-causing agents. Environmental issues, such as pollution, resource depletion, climate change, and waste management, have forced industry to change processes as a means of reducing its environmental impacts.

##### Learning Objectives

- Discuss the impact of environmental issues on industry.
- Describe environmental, health, and safety regulations.
- Identify priority pollutants in plant environments.
- Identify actions that minimize pollution.

### Fall Protection

#### Module #OSH0103

##### Description

Occupational fatalities caused by falls remain a serious public health problem throughout the U.S. Data collected by the Bureau of Labor Statistics (BLS) *Census of Fatal Occupational Injuries* indicates that falls are one of the leading causes of traumatic death in the workplace, accounting for 13.7% of such deaths (808 of 5,900) in 2001. During that year, 23 workers died in falls through skylights, 11 died in falls through existing roof openings, and 24 died in falls through existing floor openings.

Data from the BLS *Survey of Occupational Injuries and Illnesses* shows that, during 1999, nearly 300,000 workers in private industry sustained injuries from falls, resulting in lost time from work. In 1999, an estimated 80 workers were injured in falls through skylights, 100 in falls through existing roof openings, and 617 in falls through existing floor openings. Most injuries occurred in construction, though many injuries occurred in other industries such as manufacturing, retail trade, and services. OSHA emphasizes that workers remain at risk of falling through the floor, roof, skylight, and other openings. There is an increasing effort to identify fall hazards and implement prevention measures for reducing serious injuries and fatal falls.

##### Learning Objectives

- Identify the working conditions that prompt the use of fall protection.
- Describe the options that are available to protect workers from falls.
- List at least four methods of fall protection available for protecting workers.
- State the main criteria that prompts use of fall protection for construction workers.

## Fire Safety and Prevention

Module #OSH0109

### Description

Fire safety is a key element for the successful operation of industrial facilities. Fire damages are estimated to cost about \$7.5 billion per year.

Fire safety refers to the precautions that are taken to prevent or reduce the likelihood of a fire, which may result in death, injury, or property damage. To understand fire safety, it is important to know exactly what fire is and how it works.

### Learning Objectives

- Explain the fire tetrahedron.
- Describe the five classes of fire in various industries.
- Explain various fire prevention techniques.
- Explain the ways to extinguish fires.

## Industrial Signage

Module #OSH0111

### Description

This module provides an overview of the common signage found in an industrial facility. Topics covered include how to interpret common signs in an industrial facility, the color code for labels used to identify hazards, and the OSHA color code for floor markings.

### Learning Objectives

- Identify the meanings of signs commonly found in industrial facilities.
- Explain the color code for labels used to identify hazards.
- Describe the code for industrial floor markings.

## Lockout/Tagout

Module #OSH0110

### Description

The purpose of a lockout/tagout program is to establish procedures for placing lockout and/or tagout devices on energy-isolating components. Following these procedures ensures that equipment is de-energized and unexpected startup and/or release of stored energy is prevented. Injuries to personnel during equipment servicing and maintenance are greatly reduced with a properly implemented lockout/tagout program.

### Learning Objectives

- Describe the purpose of a lockout/tagout program.
- List the principles of a lockout/tagout program.
- Identify lockout/tagout devices.
- Explain the responsibilities of the authorized employee.



## Crane Safety

Module #OSH0305

### Description

Cranes pose significant safety issues, both for the operators and workers in proximity to them. Moving large, heavy loads is crucial to today's manufacturing and construction industries, and several technologies have been developed for these operations.

The *American National Standards Institute* (ANSI) and the *American Society of Mechanical Engineers* (ASME) continually update standards for crane manufacturing, operational procedures, inspection requirements, and operator qualifications. In addition, the *Specialized Carriers and Riggers Association* (SC&RA), which represents most of the crane owners and users, has developed a set of requirements for crane operator qualifications and certification.

### Learning Objectives

- List the four major causes of crane accidents.
- Describe the pre-planning that is required before putting a crane in use.
- State the main precautions that apply to working with cranes near power lines.

## H2S Awareness

Module #OSH0301

### Description

Hydrogen sulfide, or H<sub>2</sub>S, is a colorless, flammable, extremely hazardous gas with a “rotten egg” smell. People can smell the “rotten egg” odor of hydrogen sulfide at low concentrations in air. However, with continuous low-level exposure, or at higher concentrations, a person loses his/her ability to smell the gas even though it is still present (olfactory fatigue). This can happen very rapidly, and at high concentrations, the ability to smell the gas can be lost instantaneously. Therefore, DO NOT rely on your sense of smell to indicate the continuing presence of hydrogen sulfide or to warn of hazardous concentrations.

In addition, hydrogen sulfide is a highly flammable gas and gas/air mixtures can be explosive. It may travel to sources of ignition and flash back. If ignited, the gas burns to produce toxic vapors and gases, such as sulfur dioxide.

### Learning Objectives

- State the properties of hydrogen sulfide.
- Describe the health risks associated with hydrogen sulfide exposure.
- Explain the methods to minimize exposure to hydrogen sulfide.
- Identify the PPE required to work in areas with various concentration levels of hydrogen sulfide.

## Benzene Awareness

Module #OSH0302

### Description

Benzene is an organic chemical compound that naturally occurs as a component of crude oil. It is a clear, colorless liquid with a distinctive sweet odor. Benzene is flammable and its vapors can form explosive mixtures.

Benzene vapors are heavier than air and the vapors may build up or spread along the ground. These vapors can be ignited by open flames or sparks at locations remote from the site at which benzene is handled. Because of Benzene’s sweet aroma, it was used as an aftershave in the 19th and early-20th centuries. Bad idea – Benzene is a cancer-causing agent and presents significant health risks.

### Learning Objectives

- Describe the physical properties of benzene.
- State the health risks associated with benzene exposure.
- Identify possible operations that can result in benzene exposure in an industrial environment.
- State the permissible exposure limits for benzene.
- List the PPE required for environments that may have potential benzene exposure.



## Industrial Facility Safety

Module #OSH0108

### Description

More than 4,000 fatal, and 3 million non-fatal, work-related injuries were reported in the US in 2010. Identifying and understanding industrial hazards helps lower worker risk, as well as increase facility safety and efficiency.

### Learning Objectives

- Describe common hazards encountered in industrial facilities.
- Explain the dangers associated with electrical current and voltage.
- Describe the common industrial systems installed for personnel and equipment protection.

## Spill Prevention, Control, and Countermeasures

Course #OSH0603

### Description

Oil spills endanger public health, impact drinking water, devastate natural resources, and disrupt the economy. During storage, transport, or as the result of energy exploration and production activities, oil and other oil-based products are sometimes spilled onto land or into waterways. When this occurs, human health and environmental quality are put at risk. Every effort must be made to prevent oil spills and to clean them up promptly once they occur.

### Learning Objectives

- Explain spill prevention, control, and countermeasure plan.
- Describe elements of a facility response plan.
- Describe the regulations required for spill prevention.
- Explain the concepts of spill containment.
- Describe what to do in the event of a spill.

## Asbestos

Course #OSH0607

### Description

Asbestos is the name for a group of naturally occurring minerals that separate into strong, very fine fibers. The fibers are heat-resistant and extremely durable. Because of these qualities, asbestos has become very useful in construction and industry.

Asbestos tends to break down into a dust of microscopic fibers. Because of their size and shape, these tiny fibers remain suspended in the air for long periods of time and can easily penetrate body tissues after being inhaled or ingested. Due to its durability, these fibers can remain in the body for many years and, thereby, become the cause of asbestos-related diseases. Symptoms of these diseases generally do not appear for 10 to 30 years after the exposure. Unfortunately, long before its effects are detectable, asbestos-related injury to the body may have already occurred. There is no safe level of exposure known; therefore, exposure to friable asbestos should be avoided.

### Learning Objectives

- Explain the dangers of asbestos exposure.
- Describe how workers are protected and can protect themselves from asbestos hazards.
- Describe how building owners and managers are required to manage asbestos.

## GHS

Course #OSH0609

### Description

The GHS is an acronym for the *Globally Harmonized System of Classification and Labeling of Chemicals*. The GHS is a system for standardizing and coordinating the classification and labelling of chemicals. The GHS itself is not a regulation or a standard. The GHS establishes agreed hazard classification and communication provisions with explanatory information on how to apply the system. The elements in the GHS supply a mechanism to meet the basic requirement of any hazard communication system, which decides if the chemical product produced and/or supplied is hazardous and prepares a label and/or Safety Data Sheet as appropriate.

### Learning Objectives

- Recognize the importance of the GHS.
- Define health, physical, and environmental hazards of chemicals.
- Communicate hazard information, as well as protective measures, on labels and Safety Data Sheets.
- Identify the PPE required to work in areas with various concentration levels of hydrogen sulfide.



## HAZWOPER Awareness

Course #0610

### Description

The principal reason *Hazardous Waste Operations and Emergency Response* (HAZWOPER) exists is to provide fundamental training in hazardous waste procedures so that all emergency workers are coordinated and working with the same set of rules of engagement. HAZWOPER is the starting point for any emergency responder who is likely to come across nuclear, biological, or chemical (NBC) waste. Police and fire personnel, emergency medical responders, environmental response personnel, military, FEMA, Department of Health, incident commanders, and hazardous materials remediators all learn the fundamentals in a HAZWOPER course.

### Learning Objectives

- Define the term HAZWOPER.
- State the company policy concerning HAZWOPER.
- State the requirements for contractor access to the client's written safety and health plan.
- Describe the process used for a Hazardous Material cleanup.
- List the required subject areas of a written safety and health program.



## Lead Overview for Base Construction

Course #OSH0611

### Description

Inorganic lead is a malleable, blue-gray, heavy metal that occurs naturally in the Earth's crust. Lead was one of the first metals used by humans and, consequently, the cause of the first recorded occupational disease.

### Learning Objectives

- Describe the dangers of lead exposure.
- Explain the effects of lead exposure.
- Identify Lead-Based Paint Hazards and Regulations.
- Describe the hazards of lead-based paint and how it is regulated.
- Recognize how workers are protected and can protect themselves from lead hazards.

## Lead Overview for General Industry

Course #OSH0602

### Description

Inorganic lead is a malleable, blue-gray, heavy metal that occurs naturally in the Earth's crust. Lead was one of the first metals used by humans and, consequently, the cause of the first recorded occupational disease.

### Learning Objectives

- Describe the dangers of lead exposure.
- Explain the effects of lead exposure.
- Describe the hazards of lead-based paint and how it is regulated.
- Recognize how workers are protected and can protect themselves from lead hazards.

## Toxic Substance Control Act

Course #OSH0604

### Description

The *Toxic Substances Control Act* (TSCA) of 1976 provides the EPA with authority to require reporting, recordkeeping and testing requirements, and restrictions relating to chemical substances and/or mixtures. Certain substances are generally excluded from the TSCA, including, among others, food, drugs, cosmetics and pesticides.

The TSCA addresses the production, importation, use, and disposal of specific chemicals including polychlorinated biphenyls (PCBs), asbestos, radon, and lead-based paint.

### Learning Objectives

- Describe the basics of the *Toxic Substances Control Act*.
- Explain how to comply with the *Toxic Substances Control Act*.
- Describe how toxic substances are safely monitored.
- Discuss the appropriate cleanup actions in the event of a contamination.



## FOUNDATION SERIES

Despite the diversity in industrial facilities with respect to size, processes, complexity, and equipment, there are common skills and knowledge sets applicable to all industries that must be mastered for successful job performance in operations and maintenance. The topics focus on the entry-level skills and knowledge, presented within an industrial context, necessary to achieve the requisite competency for further specialization.

The *Foundation* series consists of nine core subject areas required to succeed in industry operations and maintenance from a technical perspective: Overview of Industrial Facility Systems, Safety, Mathematics, Tools, Maintenance, Environment, Computers, Print Reading, and Science.

Each module takes about 30 minutes to complete at an average pace.

# Overview of Industrial Facility Systems



## Overview of Industrial Facility Systems

Module #FOU0701

### Description

This introductory module provides an overview of industrial-scale systems, including electrical, water, and HVAC, as well as industrial standards and units of measure. These systems are used to provide examples and practical applications of the content presented in each subsequent subject area.

### Learning Objectives

- Compare and contrast residential electrical, water, and heating, ventilation, and air conditioning systems to those found in a typical industrial facility.
- Describe common facility support systems that provide water, steam, oil, instrument air, and high-pressure air within a typical industrial facility.
- Discuss the codes and standards that apply to industrial facilities.
- Identify the common units of measure used in industry.





# Safety



The modules in the *Safety* subject area begin by providing an overview of common industrial facility hazards and protective systems, including the areas of a facility where these hazards may be encountered. These modules introduce fire and electrical safety practices, as well as discuss topics such as hazardous communications, lockout/tagout, industrial signage, and personal protective equipment.

## Industrial Facility Safety

Module #FOU0801

### Description

More than 4,000 fatal and 3 million non-fatal, work-related injuries were reported in the U.S. in 2010. Identifying and understanding industrial hazards helps lower worker risk, as well as increase facility safety and efficiency.

### Learning Objectives

- Describe common hazards encountered in industrial facilities.
- Explain the dangers associated with electrical current and voltage.
- Describe the common industrial systems installed for personnel and equipment protection.

## Fire Safety

Module #FOU0802

### Description

This module covers different types of fires, fire prevention techniques, and fire extinguishing systems.

### Learning Objectives

- Explain the fire tetrahedron.
- Describe the five classes of fire in various industries.
- Explain various fire prevention techniques.
- Explain the ways to extinguish fires.

## Hazardous Communications

Module #FOU0803

### Description

This module gives an overview on how an effective hazardous communication program can prevent injuries in a work environment.

### Learning Objectives

- Explain the importance of hazardous communication.
- Describe the labeling requirements for hazardous communication, including material safety data sheets.
- Discuss the proper use of hazardous communication programs.

## Lockout/Tagout

Module #FOU0804

### Description

The purpose of a lockout/tagout program is to establish procedures for placing lockout and/or tagout devices on energy-isolating components. Following these procedures ensures that equipment is de-energized and unexpected startup and/or release of stored energy is prevented. Injuries to personnel during equipment servicing and maintenance are greatly reduced with a properly implemented lockout/tagout program.

### Learning Objectives

- State the purpose of a lockout/tagout program.
- List the principles of a lockout/tagout program.
- Identify lockout/tagout devices.
- Explain the responsibilities of the authorized employee.

## Electrical Safety

Module #FOU0805

### Description

Roughly 20% of the electricity produced in the United States every year is used to power industrial facilities and equipment. While electricity makes it possible for these facilities to operate, it also poses a very real hazard, with several hundred electricity-related fatalities occurring at the workplace every year. To avoid or treat electrical shock, one must first understand it.

### Learning Objectives

- Define electrical shock and arc flash.
- Identify emergency response actions to take in the event of an electrical shock.
- Explain electrical safeguarding.
- Identify personal protective equipment required when working on energized electrical equipment.
- List the steps required to ensure electrical equipment is de-energized.

## Industrial Signage

Module #FOU0806

### Description

This module provides an overview of the common signage found in an industrial facility. Topics covered include how to interpret common signs in an industrial facility, the color code for labels used to identify hazards, and the OSHA color code for floor markings.

### Learning Objectives

- Identify the meanings of signs commonly found in industrial facilities.
- Explain the color code for labels used to identify hazards.
- Describe the code for industrial floor markings.

## Personal Protective Equipment

Module #FOU0807

### Description

The Occupational Safety and Health Administration, or OSHA, mandates that it is an employer's duty to provide a personal protective equipment, or PPE, program designed for their workplace. The employee must follow the PPE program and use the PPE required to conform to safe work practices for their particular job. In 2003, the Bureau of Labor Statistics reported 4.4 million non-fatal injuries in private industries; this emphasizes the importance of safety in the workplace.

### Learning Objectives

- Describe personal responsibilities regarding personal protective equipment.
- List the personal protective equipment that is commonly associated with industrial sites.
- Describe the proper care, use, and inspection of personal protective equipment.
- Explain the effects of using defective or incorrect personal protective equipment.



## Benzene Awareness

Module #FOU0808

### Description

This module covers the awareness training of benzene and will answer questions such as: What is benzene? What are the health risks? Who is at risk for exposure? The module also discusses the OSHA regulatory limits, personal protective equipment, and emergency procedures associated with benzene.

### Learning Objectives

- Describe the physical properties of benzene.
- State the health risks associated with benzene exposure.
- Identify possible operations that can result in benzene exposure in an industrial environment.
- State the permissible exposure limits for benzene.
- List the PPE required for environments that may have potential benzene exposure.

## First Aid I

Module #FOU0809

### Description

This module provides guidance for effective responses and treatment related to external bleeding, burns, and nervous system injuries. Topics covered include OSHA-compliant first aid kits and how an injured person should be evaluated. In addition, this module provides an overview of how to control external bleeding, treatment of minor burns, and how to care for head, neck, and spinal injuries.

### Learning Objectives

- Describe OSHA-compliant first aid kits.
- Explain the evaluation of an injured or ill person.
- List the methods used to control external bleeding.
- Explain the treatment of minor burns.
- Describe how to care for head, neck, and spinal injuries.

## First Aid II

Module #FOU0810

### Description

This module provides an overview of basic first aid care. Topics covered include actions to take when poisoning is suspected or someone is choking. The module also explains how to perform CPR and the procedures for operating an AED device. Finally, this module describes how to identify the symptoms of a stroke.

### Learning Objectives

- Describe the actions to take when poisoning is suspected.
- List the steps for treating a choking victim.
- Explain how to perform CPR.
- Discuss the operating procedures for an AED device.
- List the symptoms of a stroke.

## Hydrogen Sulfide

Module #FOU0012

### Description

This module provides an overview of hydrogen sulfide, the hazardous properties associated with hydrogen sulfide, and the potential health effects of hydrogen sulfide exposure. This module also covers the means of protection against hydrogen sulfide and the precautionary steps that should be taken when entering a dangerous hydrogen sulfide atmosphere.

### Learning Objectives

- State the properties of hydrogen sulfide.
- Describe the health risks associated with hydrogen sulfide exposure.
- Explain the methods to minimize exposure to hydrogen sulfide.
- Identify the PPE required to work in areas with various concentration levels of hydrogen sulfide.

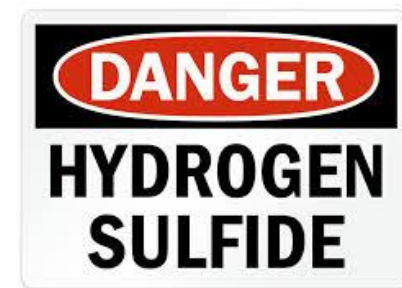

## Mathematics



*Mathematics* is one of the oldest and most fundamental sciences and is used in all aspects of modern industry in some form or another. The modules in this subject area range from basic calculations using whole numbers and fractions to problem solving and analysis using algebra and trigonometry. A working knowledge of mathematics not only improves the general efficiency of day-to-day tasks and operations, but also positively affects the economic stability of the organization.

### Whole Numbers

#### Module #FOU0201

##### Description

This module gives an overview on whole numbers and basic arithmetic operations.

##### Learning Objectives

- Explain whole numbers and number sets.
- Explain how to add and subtract whole numbers.
- Explain how to multiply and divide whole numbers.

### Fractions

#### Module #FOU0202

##### Description

This module covers fractions and introduces some mathematical functions that involve fractions.

##### Learning Objectives

- Define a fraction.
- Define a common denominator.
- Explain how to reduce fractions to their lowest terms.
- Explain how to add and subtract common fractions.
- Explain how to multiply and divide common fractions.

### Decimals and Percentages

#### Module #FOU0203

##### Description

This module covers addition, subtraction, multiplication, division, and conversion of decimals and percentages.

##### Learning Objectives

- Define the term “decimal.”
- Convert fractions to decimals and decimals to fractions.
- Define percentage and its decimal equivalent.
- Explain how to add and subtract decimals.
- Explain how to multiply and divide decimals.

## Exponents and Scientific

### Notation

Module #FOU0204

#### Description

This module covers addition, subtraction, multiplication, and division of exponents. It also gives an overview of radicals and scientific notation.

#### Learning Objectives

- Define exponents, including factors of a number.
- Define radicals, with emphasis on square roots.
- Identify examples of numbers written in scientific notation.
- Explain how to add and subtract exponential numbers.
- Explain how to multiply and divide exponential numbers.

## Fundamentals of Algebra I

Module #FOU0205

#### Description

This module explains basic algebraic terms, the use of parentheses and signed numbers, and how to add, subtract, multiply, and divide algebraic expression.

#### Learning Objectives

- Define basic algebraic terms.
- Explain the use of parentheses and signed numbers in algebraic expressions.
- Explain addition and subtraction of algebraic expressions.
- Explain multiplication and division of algebraic expressions.

## Fundamentals of Algebra II

Module #FOU0206

#### Description

This module explains axioms, how to solve algebraic expressions, explaining ratios, and proportions.

#### Learning Objectives

- State the four basic axioms for solving algebraic expressions.
- Explain the methods by which the four axioms are used.
- Explain how to solve an algebraic equation with unknown quantities.
- Define ratios and proportions and the relationship between them.

## Fundamentals of Geometry I

Module #FOU0207

#### Description

This module gives an overview of the basic principles and applications of geometry in the maintenance field.

#### Learning Objectives

- Describe the uses of geometry in the maintenance field.
- Describe the types of angles and their measurements.
- Identify the common terms of plane geometry pertaining to triangles, squares, and rectangles.
- State the formulas for calculating the perimeter of triangles, squares, and rectangles.

## Fundamentals of Geometry II

Module #FOU0208

#### Description

This module covers the different parts of a circle, finding the circumference and area of the circle, and finding the surface areas and volumes of a variety of different geometric figures.

#### Learning Objectives

- State the common parts of a circle.
- Explain how to calculate the circumference and area of a circle.
- State the formulas for calculating the surface areas and volumes of three-dimensional shapes.

## Fundamentals of Trigonometry

Module #FOU0209

#### Description

This module covers different trigonometry concepts and where these concepts might be encountered in an industrial facility.

#### Learning Objectives

- Describe the uses of trigonometry in the maintenance field.
- Discuss the use of the Pythagorean Theorem.
- Define the basic trigonometric functions.
- State the trigonometric identities.

## Scientific Calculator Use

Module #FOU0210

### Description

This module covers basic operations, calculating percentages, square roots, and scientific notation. The module also explains the trigonometric functionality of a scientific calculator.

### Learning Objectives

- Explain how to add, subtract, multiply, and divide using a scientific calculator, including order of operations.
- Explain how to calculate percentages and square roots using a scientific calculator.
- Explain how to enter numbers with exponents in scientific notation using a scientific calculator.
- Describe the trigonometric functionality of a scientific calculator.

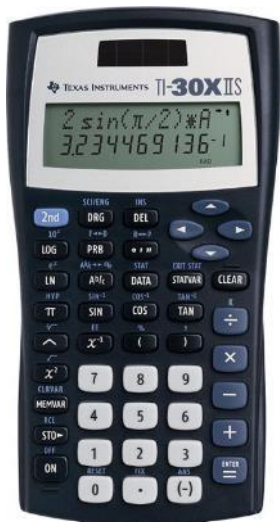

## Fundamentals of Statistics I

Module #FOU0211

### Description

This module gives a general overview of the basics of statistics.

### Learning Objectives

- Explain how to read tables and graphs.
- Explain the difference between mean, median, and mode.
- Describe a normal distribution curve.

## Fundamentals of Statistics II

Module #FOU0212

### Description

This module covers the fundamentals of statistics, such as standard deviation, distribution curve analysis, rules of probability, and how all of these subjects can be applied in an industrial setting.

### Learning Objectives

- Explain standard deviation.
- Explain how to analyze a distribution curve.
- State the rules of probability.
- Discuss industrial applications of statistical analysis.

## Introduction to Calculus

Module #FOU0213

### Description

This module covers the industrial uses for calculus, derivatives, and integrals.

### Learning Objectives

- Describe the uses of calculus in industry.
- Explain derivatives.
- Discuss integrals.

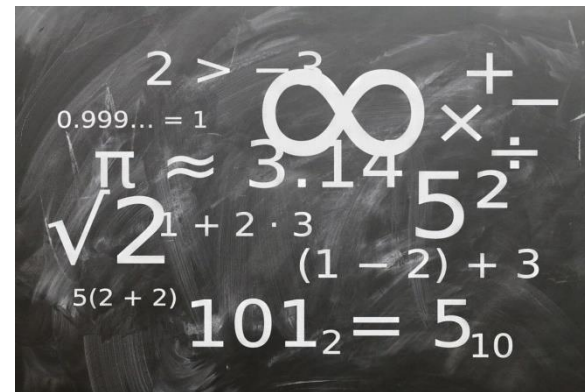



## Tools



Personnel must be familiar with common industrial tools, including their basic functions, types, and safety precautions, when working in an industrial setting, not only to complete tasks, but also to do it in the safest way possible. The *Tools* subject area of the *Foundation* series focuses on some basic hand and power tools, and spans three modules.

### Hand Tools I

Module #FOU0901

#### Description

This module covers the importance of hand tool safety, and the basic functions and types of hammers, punches, prying tools, screwdrivers and wrenches.

#### Learning Objectives

- Explain the importance of hand tool safety.
- Describe the basic functions and types of hammers, punches, and prying tools.
- Describe the basic functions and types of screwdrivers and wrenches.

### Hand Tools II

Module #FOU0902

#### Description

This module covers the basic functions and different types of cutting, gripping, holding, and measuring tools.

#### Learning Objectives

- Describe the basic functions and types of cutting tools.
- Describe the basic functions and types of gripping and holding tools.
- Describe the basic functions and types of measuring tools.

### Power Tools

Module #FOU0903

#### Description

This module explains the various types of power tools and their functions, as well as the procedures and precautions necessary for their safe operation.

#### Learning Objectives

- Describe power tool safety procedures and precautions.
- Describe the basic functions and types of stationary power tools.
- Describe the basic functions and types of portable power tools.

## Maintenance



Maintenance is a critical, yet often overlooked aspect in industrial settings. Proper maintenance can extend equipment life, yield higher operating efficiencies, and, by increasing uptime, leads to enhanced performance of assets. The *Maintenance* subject area in the *Foundation* series of modules covers different types of maintenance, including preventive and predictive, as well as explain common troubleshooting techniques.

### Preventive Maintenance

Module #FOU0101

#### Description

This module introduces preventive maintenance and its advantages. This module also covers preventive maintenance programs and computerized maintenance management systems.

#### Learning Objectives

- State the purpose of preventive maintenance.
- State the advantages and benefits of preventive maintenance.
- Describe the implementation of preventive maintenance programs.
- Describe computerized maintenance management systems.

### Predictive Maintenance

Module #FOU0102

#### Description

This module covers the purpose, tools, techniques, and benefits of predictive maintenance.

#### Learning Objectives

- State the purpose of predictive maintenance.
- Describe the tools and techniques used in predictive maintenance.
- List the benefits of predictive maintenance.

### Basic Troubleshooting

Module #FOU0103

#### Description

This module covers the purpose of troubleshooting and some basic troubleshooting techniques and methods.

#### Learning Objectives

- State the purpose of troubleshooting.
- Identify troubleshooting resources.
- Explain normal system operations and normal operating parameters.
- Describe the five-step troubleshooting process.
- Identify the components of a troubleshooting flowchart.



# Environment



Factories, machinery, and industrial processes can have a large negative impact on the environment, as evidenced by global warming, forest depletion, and the increase in toxic emissions around the world. Gaining knowledge about these issues and their causes is the foundation to increasing environmental awareness.

This subject area, *Environment*, will help to lay the groundwork to better understand how industrial factors affect the environment, and what steps can be taken to mitigate, or in some cases eliminate, negative effects to the environment.

## Environmental Awareness

### Module #FOU0301

#### Description

Since the industrial revolution in the last century, the public has become more concerned about preserving the environment and exploring the benefits of sustainability. Environmental awareness has had a major impact on industry worldwide. It has led to greater scrutiny of all industrial processes because they contribute the largest amount of environmental pollution.

The U.S. *Environmental Protection Agency*, or EPA, reported in its *Toxics Release Inventory*, or TRI, that industrial facilities release more than 6.5 billion pounds of toxic chemicals into the environment each year. Of these 6.5 billion pounds, 100 million pounds contain cancer-causing agents. Environmental issues, such as pollution, resource depletion, climate change, and waste management, have forced industry to change processes as a means of reducing its environmental impacts.

#### Learning Objectives

- Discuss the impact of environmental issues on industry.
- Describe environmental, health, and safety regulations.
- Identify priority pollutants in plant environments.
- Identify actions that minimize pollution.

## Hazardous Materials

### Module #FOU0302

#### Description

This module covers how to identify common hazardous materials, hazardous material handling and disposal procedures, and hazardous material safety precautions and regulations.

#### Learning Objectives

- Identify common hazardous materials.
- Describe handling and disposal procedures.
- Discuss safety precautions and regulations.



## Computers

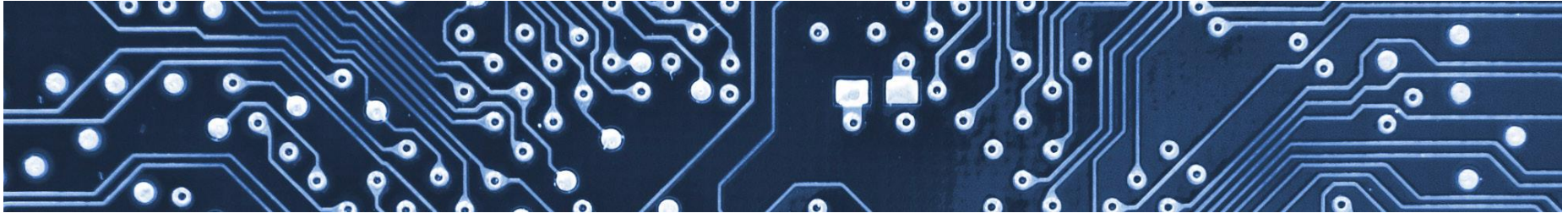

Computers have become an integral part of the work environment. Having a firm grasp on the basic workings of both personal and specialized industry computers is critical to productivity. The *Computers* subject area will cover the basics of computers.



### **Computer Use Basics**

#### **Module #FOU0401**

##### **Description**

This module covers basic computer components, file management and naming conventions, basic networking concepts, and basic commands.

##### **Learning Objectives**

- Identify basic computer components.
- Describe basic file management and naming conventions.
- Describe basic networking concepts.
- State the purpose of basic commands.

### **Computers in Industry**

#### **Module #FOU0402**

##### **Description**

This module shows how to identify the different types of computer systems and portable peripheral devices. This module also gives an overview on equipment control and computer monitoring.

##### **Learning Objectives**

- Identify the different types of computer systems.
- Describe equipment control and monitoring computers.
- Identify portable peripheral devices.

## Print Reading



Reading and understanding prints, diagrams and P&IDs are a fundamental component of working in industrial settings. When personnel can accurately and quickly determine information from drawings, they become more efficient and the facility reaps the benefits. The *Print Reading* subject area covers the fundamentals of reading industrial prints.

### Print Reading Basics

#### Module #FOU0501

##### Description

This module covers the key elements of a print diagram, as well as reading and using a print diagram.

##### Learning Objectives

- List the prints commonly used in industry.
- Explain the importance of blueprints and schematics.
- Discuss the proper use of legends.
- State the purpose of title blocks and revisions.
- Describe a block diagram.

### Piping and Instrumentation Diagrams

#### Module #FOU0502

##### Description

This module provides an overview on how to read piping and instrumentation diagrams, or P&IDs.

##### Learning Objectives

- State the purpose of piping and instrumentation diagrams.
- Discuss the information contained in the title block, notes, and legend of a typical piping and instrumentation diagram.
- Discuss the information contained in the revision block.
- Identify common symbols used on piping and instrumentation diagrams.
- Use piping and instrumentation diagrams to trace system flow paths.





## Science



Knowledge regarding the sciences that are applied in industrial contexts is critically important not only to the efficient operation of facilities, it also helps to increase personnel, as well as overall, safety. The *Science* subject area covers chemistry and physics, including work, energy, power, motion, heat transfer, fluid mechanics, gas laws, and thermodynamics.

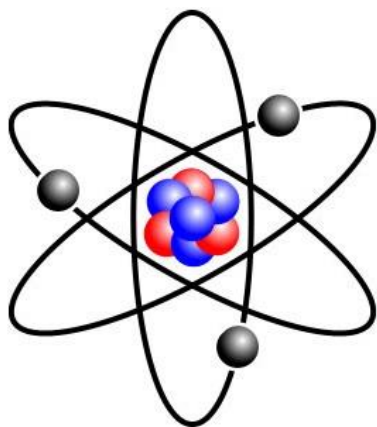

### Introduction to Chemistry

Module #FOU0601

#### Description

This module covers the fundamentals of chemistry, including mixtures, solutions, compounds, chemical properties, and methods of analysis.

#### Learning Objectives

- Identify the fundamental concepts of chemistry.
- Define compounds, mixtures, and solutions.
- Explain chemical properties.
- Identify methods of chemical analysis.

### Water Chemistry

Module #FOU0602

#### Description

This module covers the properties of water, how it is affected by impurities, how it is sampled and what it is analyzed for, and how it is treated.

#### Learning Objectives

- Describe the properties of water.
- List the types, sources, and effects of impurities in water.
- Identify the various water sampling methods.
- List the parameters monitored.
- Explain the principles of water treatment.

## Applied Physics I: Work, Energy and Power

Module #FOU0603

### Description

This module covers work, energy, and power, types of energy, the difference between potential and kinetic energy, principles of levers and inclined planes, and the operation of simple machines.

### Learning Objectives

- Define work, energy, and power.
- Describe the basic types of energy.
- Explain the difference between potential and kinetic energy.
- Identify the principles of levers and inclined planes.
- Explain the operation of simple machines.

## Applied Physics II: Laws of Motion

Module #FOU0604

### Description

This module gives an overview of English and metric units, conversion tables, force, mass, velocity, acceleration, and the laws of motion.

### Learning Objectives

- Identify English and metric units for mass, length, and derived units.
- Describe the proper use of conversion tables.
- Define force, mass, velocity, and acceleration.
- Explain the laws of motion.

## Applied Physics III: Heat Transfer

Module #FOU0605

### Description

This module gives an overview on how to define heat and temperature, explains how to calculate temperature using Fahrenheit, Celsius, and Kelvin scales, defines specific heat, including the phase changes of water, and explains the three modes of heat transfer.

### Learning Objectives

- Define heat and temperature.
- Explain how to calculate temperature using Fahrenheit, Celsius, and Kelvin scales.
- Define specific heat, including the phase changes of water.
- Discuss the three modes of heat transfer.

## Applied Physics IV: Fluid Mechanics

Module #FOU0606

### Description

This module explains the different states of matter, *Pascal's Law*, the relationship between pressure, force, and area, and the relationship between fluid flow and pipe area.

### Learning Objectives

- Identify the states of matter, emphasizing fluids.
- Explain Pascal's Law for fluid power.
- Describe the relationship between pressure, force, and area.
- Explain the relationship between fluid flow and the area of a pipe.

## Applied Physics V: Ideal Gas Law

Module #FOU0607

### Description

This module covers the different properties of gases, the laws that govern them, and how to use those laws to calculate pressure changes.

### Learning Objectives

- Describe gases and their properties.
- Explain the ideal gas law.
- Explain how to use the ideal gas law to calculate pressure change in a container.

## Applied Physics VI: Thermodynamics

Module #FOU0608

### Description

This module covers the laws of thermodynamics and introduces some of the industrial applications of thermodynamics.

### Learning Objectives

- Explain the Zeroth Law of Thermodynamics.
- Explain the First Law of Thermodynamics.
- Explain the Second Law of Thermodynamics.
- Explain the Third Law of Thermodynamics.
- Describe industrial applications of thermodynamics.

## INDUSTRIAL ELECTRICITY AND ELECTRONICS



The field of electrical and electronic technologies is vast and encompasses many technical disciplines. The *Industrial Electronics and Electricity* series is designed to minimize extraneous theory and maximize learning by targeting the essential prerequisite knowledge required for a technician in an industrial facility. The *Industrial Electricity and Electronics* series of modules explains the fundamental principles of electronic systems used in industrial settings.

In this comprehensive series, the learner is presented basic electrical principles and circuit theory, followed by key topics for an industrial technician including Motors and Servos, Power Supplies, and Work Practices. The series also provides the learner with an introduction to common equipment and systems such as distributed control, PLCs, and VFDs to prepare the learner for more in-depth training.

This series consists of 34 modules. Each module takes about 30 minutes to complete at an average pace.



## Basic Electricity Principles



The *Basic Electricity Principles* subject area focuses on basic electrical concepts and equipment as it relates to typical industrial facilities.

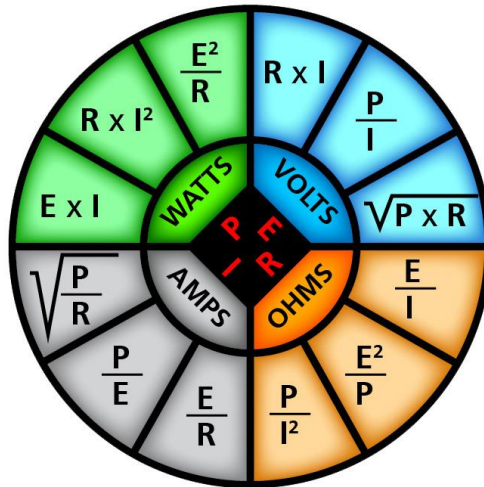

### Basic Electricity

Module #IEE0201

#### Description

This module begins with the basic principles of electricity that every technician and electrician need to know. Building on these principles, technicians and electricians will be able to grasp more advanced topics and understand the principles of operation for specific equipment found on the job.

#### Learning Objectives

- Describe how an electrical charge is created at the atomic level.
- Explain how an electrical potential difference is created.
- Differentiate between conventional current flow and electron flow.
- Describe the five main ways to produce electromotive force used in industry.

### Conductors and Insulators

Module #IEE0202

#### Description

From miniature circuit boards to the million miles of transmission lines in the world, conductors are the means to move electric currents. Every technician and electrician needs a fundamental understanding of the properties of conductors and the means to prevent current flowing to the wrong place through the use of insulators.

#### Learning Objectives

- Describe the characteristics of a good conductor of electric current.
- State the main classification types of conductors.
- List a minimum of five types of insulation.

## Resistors

Module #IEE0203

### Description

As one of the basic building blocks in modern technology, resistors are found in nearly every electrical and electronic circuit.

### Learning Objectives

- State the four main applications for resistors.
- List the five main types of resistor construction.
- Demonstrate the ability to read the value of a resistor by its color code or markings.

## Basic Laws of Electrical Circuits

Module #IEE0204

### Description

Much of the day-to-day work of an industrial electrician and technician involves taking readings and performing preventive maintenance of devices and equipment. The challenge is knowing what to do if the readings are not as expected. Mastery of a few basic laws of electrical circuits is needed to successfully analyze typical problems with circuits or equipment.

### Learning Objectives

- Explain how to use Ohm's Law to solve for unknown circuit quantities.
- Summarize Kirchhoff's Laws and how they are used to solve for unknown circuit quantities.

## Electrical Power

Module #IEE0205

### Description

A 60-watt light bulb. A 500-watt power supply. A 1,000-watt microwave. Electrical power and its unit, the *watt*, are routinely encountered and used in everyday life. Even though the term may be familiar, most people probably do not understand the concept of electrical power. As an electrician or technician, you not only need know what it is, but also be able to confidently calculate electrical power under a variety of on-the-job situations.

### Learning Objectives

- Define "electrical power."
- List different units to measure electrical power.

## Electromagnetism

Module #IEE0206

### Description

Motors, generators, servos, and many other industrial devices apply the basic principles of electromagnetism. A solid grasp of these principles is required for not only the understanding of how these devices work, but how they are controlled.

### Learning Objectives

- Describe the four characteristics of a magnet.
- Define "flux density."
- Explain how the "left-hand rule" is used to determine the relationship between polarity of a coil and the electromagnetic field.





## DC Circuits



The *DC Circuits* subject area discusses the basics of DC circuits and its roles in industrial applications.



### Batteries

Module #IEE0301

#### Description

Batteries are used throughout industry as backup or emergency power sources. They are routinely used to power mobile industrial equipment, such as automated guided vehicles. While most people are familiar with batteries used at home or in their auto, knowledge regarding how to care for and maintain batteries is less common. In industry, it is often said that batteries don't die; they are killed by neglect and misuse. Further, there are thousands of eye injuries and burns due to battery explosions each year.

#### Learning Objectives

- State the three types of electrolytes used in battery construction.
- Identify the main physical components of a storage battery.
- Explain the meaning of ampere-hour rating for batteries.

### Series Circuits

Module #IEE0302

#### Description

To safely work with series circuits, it is important to be able to calculate and understand the interactive relationships of current, resistance, and voltage.

#### Learning Objectives

- Define a series circuit.
- Calculate total resistance in a series circuit.
- Calculate total current in a series circuit.
- State the relationship between current and voltage in a series circuit.
- Calculate voltage drops across each resistor in a series circuit.

## Parallel Circuits

Module #IEE0303

### Description

To safely work with parallel circuits, it is important to be able to calculate and understand the interactive relationships of current, resistance, and voltage.

### Learning Objectives

- Define a parallel circuit.
- State the relationship between current and voltage in a parallel circuit.
- Calculate total resistance in a parallel circuit.
- Calculate branch voltage in a parallel circuit.
- Calculate total current in a parallel circuit.

## Series-Parallel Circuits

Module #IEE0304

### Description

Typical circuits encountered by a technician are rarely a pure series or parallel circuit. In practice, a combination is encountered on the job and requires application of several techniques to properly analyze circuit performance.

### Learning Objectives

- Define a series-parallel circuit.
- Calculate total resistance in a series-parallel circuit.
- Calculate branch currents in a series-parallel circuit.
- Calculate voltage drops in a series-parallel circuit.

## Switches and Relays

Module #IEE0305

### Description

The controlled application and removal of electrical current is required for every electrical circuit. Light switches and power buttons are everyday examples that we generally take for granted. However, the electrical worker needs a more comprehensive view of these devices and the various types and configurations.

### Learning Objectives

- Identify switch configurations based on schematic symbols and explain the respective switch function.
- Explain the basic purpose and operation of an electromagnetic relay.

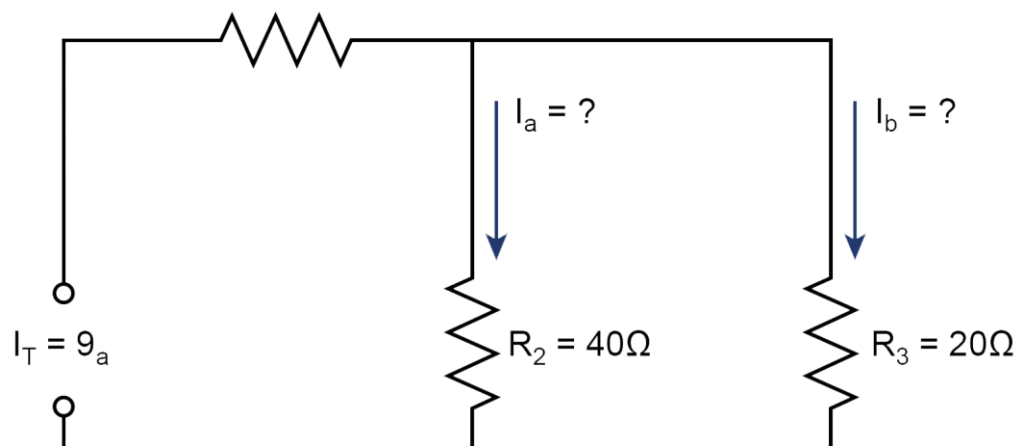

## AC Circuits



The *AC Circuits* subject area covers basics of AC power, including concepts and equipment.

### AC Generation and Basic AC Concepts Module #IEE0401

#### Description

Generally, most people are familiar with alternating current (AC) in their everyday lives. It is common knowledge that a wall socket in a home in the U.S. is 120 VAC, but did you know that the peak voltage from that wall socket is 170 volts? That fact is simply a characteristic of AC that is described in this module.

A technician must have in-depth knowledge of AC generation, characteristics, and measurement to maintain and troubleshoot industrial equipment effectively.

#### Learning Objectives

- Describe the operation of a simple AC generator.
- Explain the development of a sine wave output in an AC generator.
- Describe how a three-phase AC output is generated.
- Identify effective and average values of an AC voltage and demonstrate how to calculate each.

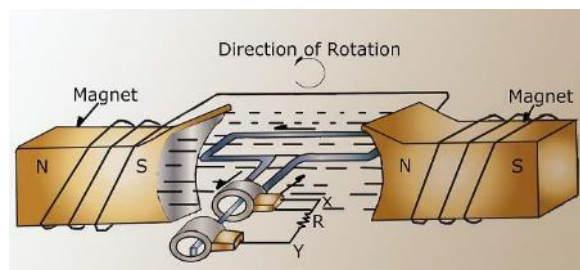

### Inductance, Capacitance, and Impedance

#### Module #IEE0402

#### Description

Resistance is a circuit characteristic that operates the same in both AC and DC circuits. However, two additional circuit characteristics are important to understand and analyze AC circuit operation: capacitance and inductance.

#### Learning Objectives

- Describe the operation of an inductor.
- Describe the operation of a capacitor.
- Calculate capacitance and inductance in a circuit.
- Calculate capacitive and inductive reactance.
- Describe the operation of a resonant circuit.

## Transformers

Module #IEE0403

### Description

Transformers are the workhorse for the manipulation and isolation of AC power. They are found in everything from small chargers to the largest power substations. While a technician rarely repairs a transformer, it is necessary to identify transformer failures. Accordingly, understanding the principle operation and applications of a transformer is a fundamental need for every technician.

### Learning Objectives

- Describe the basic construction of a transformer.
- Recognize transformer types by schematic symbols.
- Describe the operation of a transformer.
- Describe the types and applications for four possible transformer combinations.
- Explain the relationship between phase voltage and line voltage in a wye-type transformer connection.





## Motors and Servos



The *Motors and Servos* subject area focuses on basic electrical concepts and equipment as it relates to typical industrial facilities.

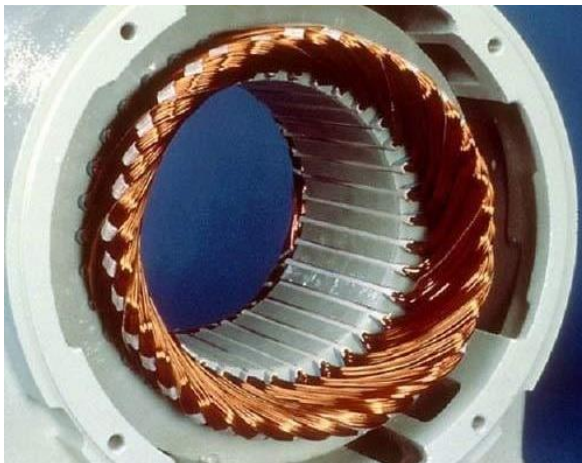

### AC and DC Motors

Module #IEE0501

#### Description

Electric motors are of the primary means to convert electrical energy into mechanical force in an industrial facility. Many different types of motors are in use for different applications. The type and application will determine the type of maintenance required to be performed by a technician, as well as typical modes of failure.

#### Learning Objectives

- Define common motor terms and definitions.
- Describe DC motors.
- Explain AC motors.
- Describe motor protection.
- Review nameplate data and motor enclosures.

### Motor Control Fundamentals

Module #IEE0503

#### Description

When a motor fails to start or stop at the desired time, the technician will be called upon to determine the problem and then resolve it. Understanding the basic principles of how motors are controlled provides the basis for being able to analyze the specific motor control circuit and determine the fault.

#### Learning Objectives

- Identify the different types of motor controllers and their basic functions.
- Examine the different types of control devices and recognize standard electrical symbols used with motor controls.
- Describe the different types of magnetic contactors.
- Examine the different types of control circuits and components used in a basic control circuit.

### Servo Drive Fundamentals

Module #IEE0502

#### Description

A servomechanism, or *servo* for short, is a type of automatic control system using feedback for precise positioning or speed control of a motor.

Servos and their drives are found in many industrial applications including robotics and machine speed control.

#### Learning Objectives

- Describe the sections of a typical AC servo drive.
- Explain how a typical AC servo drive operates.
- State the inputs and outputs of a typical AC servo drive.
- Describe a typical AC servo motor.



## Semiconductors



The *Semiconductors* subject area covers semiconductors and its relevance, use, and maintenance in an industrial setting.



### Diodes

#### Module #IEE0601

##### Description

A diode is an electrical device allowing current to move through it in one direction with far greater ease than in the other. The most common kind of diode in modern circuit design is the semiconductor diode.

##### Learning Objectives

- Describe construction and operation of diodes.
- Identify schematic symbols for different types of diodes.
- Describe operating characteristics for rectifier, Zener, and light-emitting diodes.

### Bipolar Transistors

#### Module #IEE0602

##### Description

The transistor, invented in the early 1950s, revolutionized the field of electronics. Replacing the tube as an amplifying device, it soon became the fundamental building block for modern electronics. The bipolar transistor evolved from a single packaged device into many transistors embedded on a single integrated chip.

##### Learning Objectives

- Identify NPN and PNP transistors.
- Explain biasing NPN and PNP transistors.
- Identify common-emitter, common-collector, and common-base bipolar transistor configurations.



## Other Semiconductors

Module #IEE0603

### Description

Semiconductor devices are the building blocks of electronic devices. They are used to control and modify electrical power and signals. The devices in this module are used in power supplies, oscillators and amplifiers. A good grasp of the operation of them will aid in understanding and troubleshooting electronic circuits.

### Learning Objectives

- Summarize the construction and operation of SCRs.
- Describe the construction and operation of DIACs and TRIACs.
- Explain the construction and operation of UJTs and FETs.

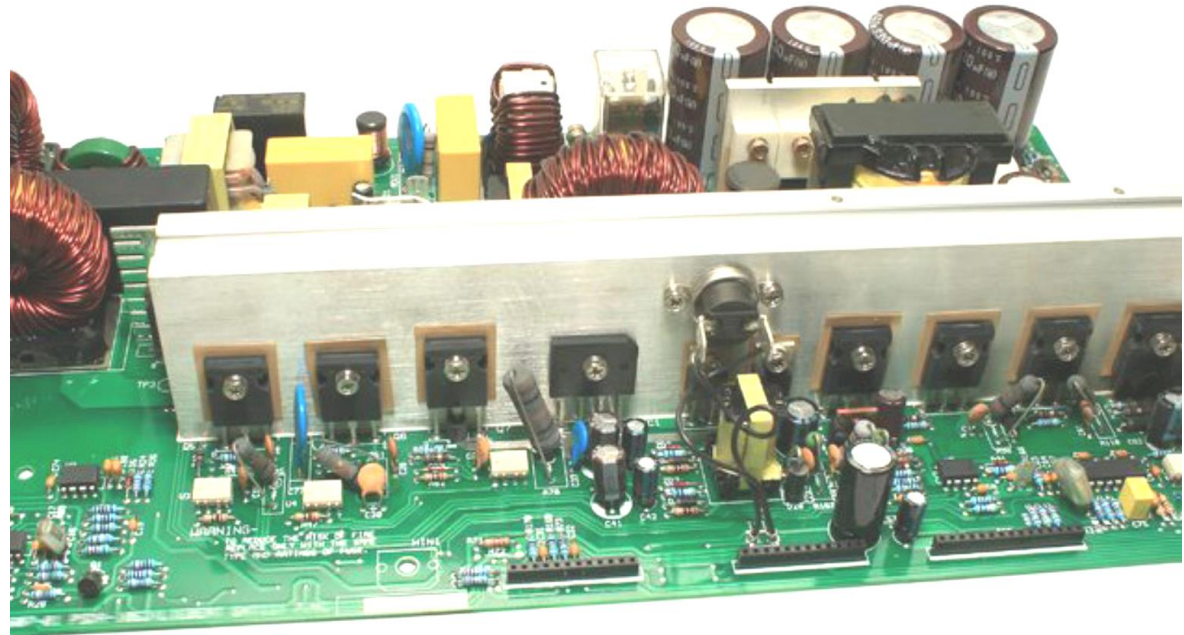

## Power Supplies



The *Power Supplies* subject area describes the operation and components required to maintain a safe power circuit.



### Power Supplies

#### Module #IEE0701

##### Description

Power supplies supply regulated power to devices we see every day. From computers and cell phones to televisions and plant instrumentation, the power supply provides regulated power for proper operation.

##### Learning Objectives

- Describe the operation of a power supply rectifier.
- Explain the function of a power supply filter.
- Describe the operation of a voltage regulator.

### Uninterruptible Power Supplies

#### Module #IEE0702

##### Description

Uninterruptible power supplies (UPS) provide backup power on loss of main power to a system. The UPS is sometimes called a *switching power supply* and differs from a backup system, such as a diesel, in that it provides instantaneous switchover on loss of power. The principles of operation are the same whether backing up a desktop computer or a large power system.

##### Learning Objectives

- Describe the operation of the power switching circuit.
- Explain the basic operation of a rectifier circuit.
- Explain the operation of the battery charger circuit.

## Fuses

### Module #IEE0703

#### Description

Electrical circuits and components are rated to withstand a certain amount of current flow. Excessive current in a circuit results in overheating and destruction of components. Various protective methods can prohibit the occurrence of overheating by creating a weak link in the circuit that will fail under certain conditions. A commonly used protective device is the fuse.

#### Learning Objectives

- State the purpose of a fuse.
- List common types of fuses.
- Explain the ratings used for fuses.
- Describe how to check for an open fuse.

## Circuit Breakers

### Module #IEE0024

#### Description

The circuit breaker serves the same purpose as the fuse, with some notable advantages. Not only is a circuit breaker resettable, it is safe, reliable, tamper proof, and can be used, if specifically designed to do so, as a circuit control device that can switch power on and off to a connected system. This module explains the purpose, types, ratings, and operations of the circuit breaker.

#### Learning Objectives

- State the purpose of a circuit breaker.
- List common types of circuit breakers.
- Explain the ratings used for circuit breakers.
- Describe how to check for and reset an open circuit breaker.



## Digital Electronics



The *Digital Electronics* subject area covers common digital electronics that personnel would be required to use in an industrial setting.

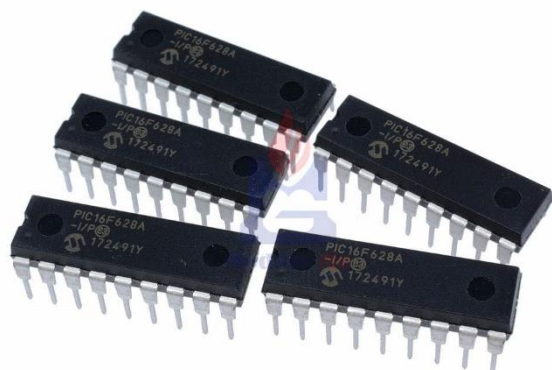

### Communication and Controls I Module #IEE0801

#### Description

Industrial devices communicate with each other using standard methods for accuracy and compatibility of data. This module introduces the communication methods.

#### Learning Objectives

- Describe data communications and list several applications.
- Introduce telemetry, its history, and its applications.
- Explain the main types of network protocols.

### Communication and Controls II Module #IEE0802

#### Description

Data communication between devices is transmitted over a network of wires, fiber optics, or through the atmosphere wirelessly. Communication media needs to be properly installed and maintained for accurate information to transfer.

#### Learning Objectives

- Define network topology and the main types of networks.
- Describe installation and troubleshooting skill sets, tools, and best practices.



## Introduction to PLCs

Module #IEE0803

### Description

Programmable logic controllers, or PLCs, are used to automate processes in industry. In the 1960s, the computerized processor replaced the relay logic control system. With the widespread use of PLCs in today's automation industry, a technician is required to have a good understanding of their operation to perform maintenance and troubleshooting procedures.

### Learning Objectives

- List the basic components of a PLC.
- Describe the basic operation of a PLC.
- Define the three stages of a scan cycle.
- Discuss the ladder logic diagram of a hardwired system.

## Introduction to VFDs

Module #IEE0804

### Description

Variable Frequency Drives (VFDs) control the speed of motors by varying the frequency of the supplied power. This provides accurate control of the motor speed and also reduces energy consumption. Many VFD brands exist in the marketplace. This module presents the operation of a typical VFD.

### Learning Objectives

- Describe AC variable frequency drive theory.
- Identify the three functional sections of a typical VFD.
- Identify typical VFD faults and how they are interpreted.
- Describe the Human Interface Module control panel and programming characteristics.

## Logic Gates and Number Systems

Module #IEE0805

### Description

The basic building blocks of digital electronics are the logic gates. Most logic gates have two inputs and one output in one binary state of low or high, represented by different voltage levels. Counting performed by these logic gates occurs in a binary number format. Understanding the building blocks of digital circuits will aid in troubleshooting.

### Learning Objectives

- List the basic logic gate types.
- Explain the operation of logic gate circuits.
- Understand the different numbering systems used in digital circuits.



## Work Practices



The *Work Practices* subject area covers basic operations required to be understood for personnel at an industrial facility, including those for safety, testing, and troubleshooting.



### Print Reading

#### Module #IEE0101

##### Description

One of the fundamental skills that must be mastered by a craftsperson is print reading. Prints are the building blocks that standardize manufacturing and aid in troubleshooting.

##### Learning Objectives

- Describe the different types of mechanical drawings and the typical parts of a drawing.
- Describe the different types of electrical drawings.
- Explain the symbols used in each type of drawing.

### Grounding Practices

#### Module #IEE0102

##### Description

Grounding of electrical equipment is necessary for safety, for signal accuracy, and to minimize interference in a circuit. Understanding proper grounding techniques will help in troubleshooting and may save your life.

##### Learning Objectives

- Define grounding and why it is necessary.
- Explain common problems that can occur in grounding systems.
- Describe the types of grounded electrical systems.
- Review basic requirements for equipment grounding and bonding.
- Describe the importance of an effectively grounded system.
- Explain common grounding faults.



## Test Equipment

Module #IEE0103

### Description

Test equipment are the tools of the trade for technicians. They are needed for safety, for information and for troubleshooting equipment. Understanding the types available and their application will make you a better technician.

### Learning Objectives

- Describe multimeters and their use.
- Identify common electrical testers.
- Explain megohmmeters and their use.
- Discuss thermal imaging.

## Electrical Safe Work Practices

Module #IEE0104

### Description

*Electricity* is a powerful force that can damage equipment, injure or even cause death if not properly controlled. Working around electricity requires caution to prevent accidental contact with energized equipment. Several regulations exist on the proper use of personal protective equipment and safety precautions, but it is ultimately up to the worker to prevent accidents.

### Learning Objectives

- Identify the specific hazards associated with electrical energy.
- Discuss the qualifications required to work on energized electrical equipment.
- Explain the different boundaries associated with Electrical Safe Work Practices.
- Identify the personal protective equipment required to work on or in the vicinity of energized equipment.

## Troubleshooting

Module #IEE0105

### Description

*Troubleshooting* is a method for finding the root cause of a problem and correcting it. The ultimate goal of troubleshooting is to get the equipment back into operation. An entire production operation may depend on the troubleshooter's ability to solve a problem quickly and economically.

At times, such a task might present itself as a daunting process. Fortunately, technicians have, through trial and error, adopted a series of best practices that, if followed, will make the task of troubleshooting any equipment or process much more intuitive. Sticking to these best practices and adopting a logical approach to solving the problem is always the best way to resolve the situation at hand.

### Learning Objectives

- Describe the end goal of troubleshooting.
- Identify the resources used to assist troubleshooting efforts.
- Diagnose faults using the divide and conquer troubleshooting method.
- State the seven-step troubleshooting process for systematic troubleshooting.

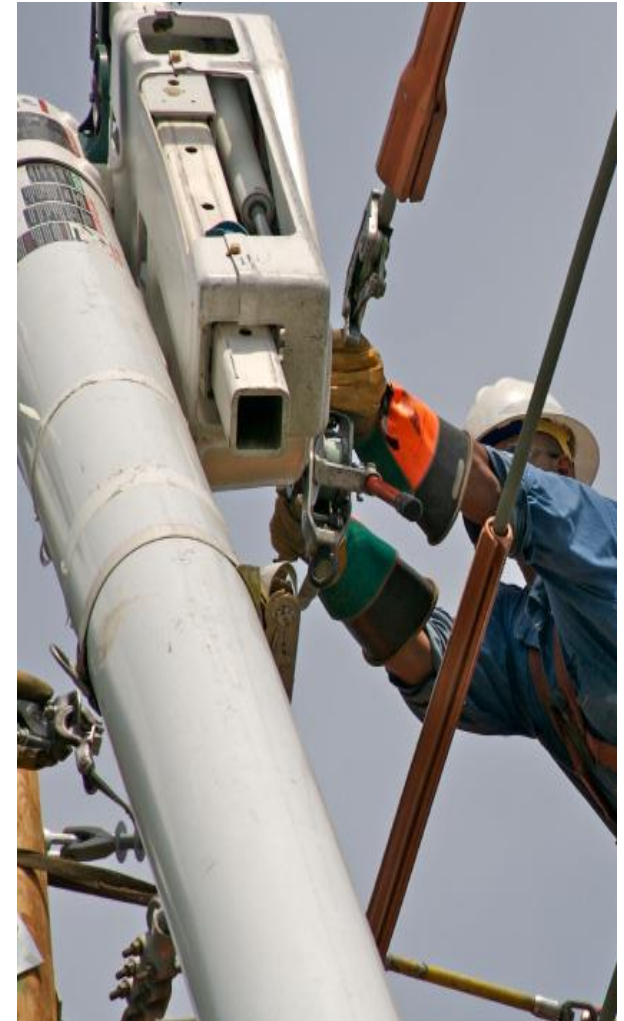

## MECHANICAL



All industrial facilities use mechanical equipment in one form or another. Although the types of mechanical equipment can run the gamut from simple open/close valves to ultra-complex, specialized purpose-built machinery, the underlying operating principles and concepts are rooted in solid mechanical fundamentals.

The *Mechanical* series consists of 13 subject areas and a total of 75 modules, including Bearing Maintenance, Industrial Hydraulic Fundamentals, Industrial Pneumatic Fundamentals, Lubrication Concepts, Mechanical Transmission Systems, Pipes and Pipefitting, Precision Measuring Instruments, Pumps, Rigging, Shaft Alignment, Static and Dynamic Sealing, Valve Fundamentals, and Welding Fundamentals.

Each module takes about 30 minutes to complete at an average pace.

# Industrial Hydraulic Fundamentals



Hydraulics plays a vital role in industrial facilities, including being used for equipment control and power transmission systems.

The *Industrial Hydraulic Fundamentals* subject area covers the operation of common industrial hydraulic systems and the science behind it, which must be understood in order to competently operate and troubleshoot a hydraulically powered system.



## Hydraulic Theory

### Module #MEC0201

#### Description

Originally, the science of hydraulics covered the physical behavior of water at rest and in motion. The term has broadened its meaning to include the physical behavior of all liquids. This includes that area of hydraulics in which confined liquids are used under controlled pressure to do work. This area of hydraulics is sometimes referred to as *power hydraulics*. To safely and correctly operate a power hydraulic system, it is necessary to understand how the fluid behaves and why it behaves the way it does.

#### Learning Objectives

- Describe the development and applications of modern hydraulics.
- Define and differentiate between pressure and force.
- Explain how Pascal's law applies to fluid power applications.
- Describe the role pressure and force play in hydraulic systems and how it is accomplished.
- Explain the relationship between volume and velocity of flow.

## Hydraulic Components I

### Module #MEC0202

#### Description

The use of hydraulics to transmit power has reached almost every facet of the industrial world. These hydraulic systems are composed of the hydraulic fluid itself, pipes and tubes used to transport the fluid, and components that perform a variety of functions. To understand how a hydraulic system works, it is important to understand the functions of the various components and how they operate.

#### Learning Objectives

- Describe the different types and uses of filters.
- Identify the three general classes of piping used in hydraulic systems
- Describe the types and uses of seals found in hydraulic systems.
- Explain the basic operation of the different types of pumps used in hydraulic systems.

## Hydraulic Components II

Module #MEC0203

### Description

The use of hydraulics to transmit power has reached almost every facet of the industrial world. These hydraulic systems are composed of the hydraulic fluid itself, pipes and tubes used to transport the fluid, and components that perform a variety of functions. To understand how a hydraulic system works on the whole, it is important to understand the functions of the various components and how they operate.

### Learning Objectives

- State the function of a reservoir.
- Describe the types and uses of accumulators used in hydraulic systems. Describe the types and uses of control valves used in hydraulic systems.
- Describe the function of a relief valve.
- Describe the types and uses of cylinders and actuators used in hydraulic systems.

## Hydraulic Systems

Module #MEC0204

### Description

The use of hydraulics to transmit power has reached almost every facet of the industrial world. With an understanding of hydraulic theory and the various types of hydraulic components, it is possible to understand the designs and functions of an entire hydraulic system. Knowledge of how these systems operate and the ability to read system schematics are crucial to the proper operation and maintenance of any hydraulic system.

### Learning Objectives

- Describe a basic hydraulic system.
- Describe the different types and properties of hydraulic fluids.
- Identify symbols used on hydraulic schematics.
- Explain the operation of a hydraulic circuit, given a system schematic.





# Industrial Pneumatics Fundamentals



Pneumatic systems, or simply those using the power of compressed gases to perform various functions, necessitates that personnel understand the fundamentals of pneumatic operation, individual components within a system, a system as a whole, and the theories behind pneumatic operation. A firm grasp of these concepts can ensure a safer work environment with decreased equipment down time.



## Pneumatic Theory I

### Module #MEC0301

#### Description

Pneumatic systems, like hydraulic power systems, are classified as fluid power systems. The term *hydraulics* refers to a liquid used as the fluid, while the term pneumatic specifies a system that uses a compressed gas as the fluid. The gas most commonly used is compressed air, although some applications may use other gases, such as nitrogen or carbon dioxide.

#### Learning Objectives

- State the advantages of fluid power.
- Describe the two major differences between liquids and gases.
- State the formula used to compute force and pressure.
- Explain how changes in one parameter will affect the other parameters in a pneumatic system.
- Explain the significance of the amount of fluid flow in a pneumatic system.

## Pneumatic Theory II

### Module #MEC0302

#### Description

The use of pneumatics has become a large part of industrial operations and maintenance. Pneumatic systems and tools reduce required work, reduce time required, and increase efficiency over manual operations. This module explains how these things are accomplished.

#### Learning Objectives

- List the five physical factors that act upon a fluid.
- State four advantages of pneumatic systems.
- Describe three common pneumatic applications.
- Identify pneumatic symbols on a schematic.

## Pneumatic Components I

Module #MEC0303

### Description

A basic understanding of the individual components of a pneumatic system is key to maintaining efficient and hassle-free operation. This module, *Pneumatic Components I*, is the first in the process, and covers some common components found in a pneumatic system, including purification equipment, filters, lubricating devices, and pneumatic cylinders.

### Learning Objectives

- State the purpose of purification equipment used in pneumatic systems.
- State the purpose of filters used in pneumatic systems.
- Describe two types of moisture-removing equipment used in pneumatic systems.
- Describe two types of compressed air system lubricating devices used in pneumatic systems.
- State the purpose of pneumatic cylinders.

## Pneumatic Components II

Module #MEC0304

### Description

In *Pneumatic Components II*, the focus is shifted to control valves required in pneumatic systems and the components and tools that translate energy in the system into some form of useful work.

### Learning Objectives

- State the purpose of pneumatic control valves.
- Describe the different elements of pneumatic control valves.
- Explain the function of air receivers in pneumatic systems.
- Explain the function of pneumatic motors in pneumatic systems.
- State the three broad classifications of pneumatic tools.

## Pneumatic Systems

Module #MEC0305

### Description

Pneumatic systems serve a variety of uses in the industrial world. They range from simple stand-alone systems used to power pneumatic tools to complex systems used to automatically control intricate processes. Safe and efficient operation is dependent upon the operator's ability to read the schematics for these systems and understand how the components work together.

### Learning Objectives

- Describe a simple pneumatic system.
- Identify symbols used on pneumatic schematics.
- Explain the operation of a simple pneumatic circuit.
- Explain the operation of pneumatic timing and safety circuits.
- Explain the operation of a complex pneumatic circuit.





## Air Compressor I

Module #MEC0306

### Description

Compressors are machines that create high-pressure gas or liquid through staged compression.

Compressors can provide pressure through single and multiple stages, ranging from 25 psig to 10,000 psig.

### Learning Objectives

- Describe the basic principles of compressor operation.
- Identify the different types of positive displacement compressors.
- List the advantages and disadvantages of the different positive displacement compressors.

## Air Compressor II

Module #MEC0307

### Description

Water droplets will form when air is saturated with water vapor. This condensation point, known as the *dew point*, varies with pressure and temperature. The higher the temperature at a given pressure, the more moisture can be contained in the air before it is saturated. When air moves from the compressor along a pipeline, its temperature drops and water forms in the line. The greatest cooling occurs when the air is expanded or used in doing expansive work. If the dew point is not lowered by drying prior to this time, damage may occur in the form of corrosion, spray from equipment exhaust, rusting, and moistening of working parts.

### Learning Objectives

- Describe the basic principles of compressor intercoolers and aftercoolers.
- Identify the different types of compressed air dryers.
- List the advantages and disadvantages of air accumulators.

## Air Compressor III

Module #MEC0308

### Description

Rotary screw compressors are the workhorses behind most manufacturers worldwide. If you see a big building and they make stuff there, there's a good chance there is a rotary screw air compressor powering their manufacturing process.

### Learning Objectives

- Describe the basic principles of compressor intercoolers and aftercoolers.
- Identify the different types of compressed air dryers.
- List the advantages and disadvantages of air accumulators.



## Precision Measuring Instruments



The term “precision measurement” is applied to the measurement field beyond the scope of line graduated, non-precision measuring instruments such as the ruler and scale. It refers to the art of reproducing and controlling dimensions expressed in thousandths of an inch, or millimeter.

This subject area begins with an overview of the purpose of precision measurement instruments, including the difference between direct and indirect measurements, how accuracy is defined, and the categories of precision measurement tools.

The subsequent modules introduce specific instruments, such as micrometers, vernier calipers, dials and indicators, and gauges.



### Precision Measuring Instruments

**Course #MEC0101**

#### Description

“Measure twice, cut once,” is a phrase that is often heard in the working world. This phrase simply means that if the measurement is not correct, the cut will not matter. To minimize the chance of a “bad cut”, the development of precision measuring instruments came about. These tools provide a very precise measurement to allow a reading in the thousandths of an inch or millimeter. Precision measuring tools can be used for detailed measurements of inside diameter, outside diameter, roundness, surface finish, lengths, and depths.

#### Learning Objectives

- State the purpose of precision measuring tools.
- Explain the difference between direct and indirect measurements.
- Define “accuracy” and “error.”
- List the different categories of precision tools.

### Micrometers

**Course #MEC0102**

#### Description

In this module, you will learn about several different types of micrometers, what each of them should be used for, and how to properly use them. You will also learn how to read a micrometer and techniques to prevent mistakes when taking measurements.

#### Learning Objectives

- Discuss the parts of a micrometer.
- Explain how to make measurements with an outside micrometer.
- Explain how to take measurements with an inside micrometer.
- Explain how to take measurements with a depth micrometer.
- Describe the methods used to maintain a micrometer.

## Vernier Calipers

Course #MEC0103

### Description

The modern vernier caliper, which reads to thousandths of an inch, was invented by American Joseph R Brown in 1851. It was the first precision measurement tool that was priced reasonably enough for most machinists. The ability to make precise measurements was instrumental in producing modern interchangeable parts.

### Learning Objectives

- Discuss the parts of a vernier caliper.
- Explain how to read a vernier caliper.
- Explain how to take inside and outside measurements using a vernier caliper.
- Describe the methods used to maintain a vernier caliper.

## Dial Indicators

Course #MEC0104

### Description

In the modern age of precision, the ability to measure any difference from the standard measurement is essential to ensure equipment longevity and accuracy. There is also a need for exact measurements of lash or play in equipment components to prevent binding. The dial indicator provides the ability to measure both of these variances as well as many others.

### Learning Objectives

- State the purpose of dial indicators.
- Describe the different types of dial indicators.
- Taking Measurements with a Dial Indicators
- Describe how to take measurements with a dial indicator.

## Fixed Gauges

Course #MEC0105

### Description

Many different types of measuring devices are used for dimensional inspection. The primary factors involved in selecting the best device are the type of dimension to be measured, the tolerance of the dimension, and the characteristics of the measuring device. This module describes several types of fixed gages with particular attention given to their application.

### Learning Objectives

- List the common types of fixed gauges.
- Explain limit gauges for length dimensions.
- Explain cylindrical limit gauges.
- Explain fixed gauges for multiple dimensions.

## Pumps



Pumps are at the heart of an industrial facility's operations. Fluids would not be able to move efficiently between points if not for the use of pumps. Having knowledge about types of pumps and typical maintenance issues will help to ensure that personnel can safely and efficiently address problems that arise in the field.

The *Pumps* subject area covers centrifugal, positive displacement, and special purpose pumps, as well as maintenance and seals.



### Pump Design Module #MEC0401

#### Description

Pumps have been used to enhance life since 2,000 BC with the creation of the shadoof by the Egyptians. Since that time, there have been many advances, both in design and purpose. Pumps can be used to move solids, liquids, and gases from one place to another. They also can be used to raise the pressure in a system for hydraulic operations. Today, most pumps are classified as centrifugal or positive displacement pumps. To adequately understand and use each pump, it is important to first understand the purpose, design, and common terms associated with pumps.

#### Learning Objectives

- State the purpose of a pump.
- State the two major pump classifications.
- Define common pump terminology.

### Centrifugal Pumps Module #MEC0402

#### Description

This module introduces centrifugal pumps, which are the most widely used type of pump. The popularity of these pumps is due to the simplicity of construction, one rotating element, small space requirements, and ability to operate at high speeds when directly connected to turbines or motors. After a discussion of the components and operation of centrifugal pumps, the various pump laws are introduced.

#### Learning Objectives

- Describe the principles of operation for centrifugal pumps.
- Identify the major pump components.
- Describe common design aspects.
- State the three centrifugal pump laws.

## Positive Displacement Pumps

Module #MEC0403

### Description

Positive displacement pumps are used in systems where a set amount of fluid needs to be delivered at all times. These types of pumps are not used in systems where flow rates change often during operation. This module provides an overview of the different types of positive displacement pumps and where they are used.

### Learning Objectives

- Describe the operation of positive displacement pumps.
- Describe the operation of reciprocating pumps.
- Name two types of reciprocating pumps.
- Name three types of rotary pumps.
- Describe the operation of rotary pumps.

## Special-Purpose Pumps

Module #MEC0404

### Description

This module introduces participants to special-purpose pumps. This class of pumps is comprised of centrifugal and positive-displacement pumps that are built for specific applications. Special-purpose pumps can be metering pumps for precise addition of chemicals to control boiler water chemistry or diaphragm pumps that are used for pumping corrosive fluids such as caustic and acid solutions. This module provides an overview of the different types and uses of special-purpose pumps.

### Learning Objectives

- State the purpose and describe the operation of metering pumps.
- State the purpose and describe the operation of plunger pumps.
- State the purpose and describe the operation of diaphragm pumps.
- State the purpose and describe the operation of screw pumps.
- State the purpose and describe the operation of peristaltic pumps.

## Pump Maintenance

Module #MEC0405

### Description

This module introduces basic pump maintenance and explains how troubleshooting, in a logical, step-by-step manner, can save time and money. The *Pump Maintenance* module introduces common pump failures and provides an overview of preventive and predictive maintenance procedures.

### Learning Objectives

- Discuss common pump failures.
- List common preventive maintenance procedures.
- Discuss common predictive maintenance techniques.

## Mechanical Seals

Module #MEC0406

### Description

The sealing of rotating shafts at the point of entrance to a pressure chamber has for years been accomplished with a stuffing box seal. A serious deficiency of the stuffing box-type seal is that it will allow some amount of leakage. With the development and perfection of mechanical seals, this leakage problem has all but vanished. The module provides an overview of how the different types of mechanical seals operate, and how individual components of the seal function.

### Learning Objectives

- State the purpose of mechanical seals.
- Explain how a mechanical seal operates.
- Identify mechanical seal properties.
- Describe the functionality of mechanical seal components.
- Discuss the types of mechanical seals and seal arrangements.



## Static and Dynamic Sealing



Equipment and piping must be able to keep in, or out, critical process fluids and hazardous gases to operate safely and efficiently. Seals, including gaskets and packing, fill the role for a variety of applications. The *Static and Dynamic Sealing* subject area covers not only seals, but also common methods of connecting equipment and piping.



### Packing

Module #MEC0501

#### Description

Many systems found in industrial environments contain gases and liquids at high temperatures or pressures, or fluids that are otherwise inherently dangerous, such as ammonia. Within these systems are components that break the boundaries of the system with moving parts, like the stem of a valve or the shaft of a pump. To prevent the fluid within these systems from escaping to the atmosphere, packing is installed that can seal the component yet still allow relative motion between its parts. It is important to understand how this packing works, how it is installed, and what must be done to maintain it in a proper working condition.

#### Learning Objectives

- State the purpose of packing.
- Describe various packing configurations.
- Describe the construction of various types of packing.
- State the purpose of lantern rings and throttle bushings.
- Discuss the proper method for renewing packing.

### Gaskets

Module #MEC0502

#### Description

Gaskets are widely used throughout industry to prevent leakage between stationary surfaces. Gasket replacement is an important maintenance job that saves money and down time. Therefore, it is important for industry personnel to learn about the types of gaskets, as well as how to safely cut, replace, and install gaskets.

#### Learning Objectives

- State the purpose of gaskets.
- Describe the installation procedure for rubber gaskets, cork gaskets, and foam rubber gaskets.
- Explain the procedure for cutting and installing a contoured gasket.



## Bolted Joints I

Module #MEC0503

### Description

Two common concerns in industrial facilities are leaking joints and vibrating equipment. These problems lead to excessive repair costs every year. This module explains the importance of proper torque for a bolted joint and the stresses that can affect the joint.

### Learning Objectives

- Explain the need for proper fastener torque.
- Describe the various stresses placed on a fastener in a bolted joint.
- Describe the various types of bolted joints.
- Explain how differential loading affects a joint's leak integrity.
- Discuss the effects of vibration on a bolted joint.



## Bolted Joints II

Module #MEC0504

### Description

There are many methods in place to attempt to prevent a mechanical joint from loosening. Some methods start at the initial design of the bolted joint with the selection of the flange surface finish and face design. Another important part of the bolted joint is the selection and use of the bolts or stud bolts.

### Learning Objectives

- Discuss various methods available to prevent bolts from loosening.
- Define bolted joint relaxation.
- Identify various flange surface finishes and their application.
- Identify various flange face designs and their application.
- Discuss the design and proper use of stud bolts.

## Threaded Fasteners

Module #MEC0505

### Description

Since their mass production and standardization became possible in the late 18th century, threaded fasteners have played a large role in industry. The strength, versatility, ubiquity, and low cost of threaded fasteners has resulted in their use in everything from structural supports for buildings to the bolts used to mount a motor to its base. While relatively simple in design and construction, selecting the proper fastener can be a very important choice. Many industrial disasters and fatalities have been attributed to a poorly chosen or defective fastener.

### Learning Objectives

- Define the major terms relating to screw threads.
- Discuss the various classes of fit.
- Describe thread specifications for unified and metric threads.
- Explain the various mechanical properties of threaded fasteners.
- Discuss the advantages and disadvantages of different fastener materials.

## Torque and Tension

Module #MEC506

### Description

When is a fastener tight? The complete answer relies on the understanding of torque and tension, and how they are applied to bolts and threaded fasteners.

### Learning Objectives

- Define torque and tension.
- Discuss methods used to control torque.
- Describe the methods used to measure torque.
- Perform calculations of applied torque using extensions.

## Valve Fundamentals



Instrumentation controls, such as those needed to control the flow of liquid, requires the use of a final control element. The final control element, typically a valve, is the last active device in an instrument control loop that directly controls the process or manipulated variable. This subject area, *Valve Fundamentals*, covers the fundamentals of valves, actuators, and their operation.



### Basic Types and Operations I Module #MEC0701

#### Description

On June 11, 2008 at the Goodyear plant in Houston, Texas, a heat exchanger violently ruptured due to an over pressurization caused by the isolation of a pressure relief valve. An employee walking nearby was killed by the hurtling debris from the explosion. An understanding of the importance of these valves and their proper positioning could have prevented this incident. In this module, several types of these valves and their common components will be briefly discussed, as well as the proper mounting and installation guidelines.

#### Learning Objectives

- State the purpose of valves.
- List the main components of several styles of valves.
- Describe the methods of valve mounting in several styles of systems.

### Basic Types and Operations II Module #MEC0702

#### Description

Isolation or insufficient flow can result in instantaneous over-pressurization and/or explosions; therefore, the proper positioning of isolation and throttle valves is crucial to the safe operation of any system. Gate, globe, needle, and butterfly valves are all used to stop, start, and throttle flow.

#### Learning Objectives

- Describe the construction and operation of gate valves.
- Describe the construction and operation of globe valves.
- Describe the construction and operation of needle valves.
- Describe the construction and operation of butterfly valves.

## Basic Types and Operations III

Module #MEC0703

### Description

Flow reversals and improper flow rates can lead to equipment failure and destruction. By understanding valve operations and ensuring proper valve orientation, these situations can be avoided. Ball valves and plug valves are used to stop, start, and throttle flow, while the check valve is used to prevent flow reversal, and the regulating valve is used to automatically adjust flow.

### Learning Objectives

- State the purpose, operation, and construction of a ball valve.
- State the purpose, operation, and construction of a plug valve.
- State the purpose, operation, and construction of a check valve.
- State the purpose, operation, and construction of a regulating valve.

## Relief and Safety Valves I

Module #MEC0704

### Description

Many industrial facilities use pressurized liquids and gases in systems to perform functions, such as tool and instrument operation, energy production, and heating and cooling. All systems, regardless of how well they were engineered or the quality of the materials used, will have a maximum pressure they can withstand before a failure occurs. A system that fails in this manner can result in production downtime, destruction of expensive equipment, and even loss of life.

### Learning Objectives

- State the purposes of relief and safety valves.
- Define terms related to relief valves.
- Describe the functional differences between safety and relief valves.

## Relief and Safety Valves II

Module #MEC705

### Description

Industrial facilities use piping systems and tanks to transport and store water, steam, and gases at various temperatures and pressures. Although the pressures in these systems are carefully monitored and adjusted, operator error or an equipment malfunction can result in a loss of pressure control. If pressure is allowed to increase or decrease beyond the tolerances of the system containing the fluid, a catastrophic failure can occur. Relief and safety valves are used to prevent this from occurring, thereby avoiding equipment damage and personnel injury.

### Learning Objectives

- Describe the construction and operation of a typical direct-acting relief valve.
- Describe the construction and operation of a typical pilot-actuated relief valve.
- Describe the construction and operation of a typical safety relief valve.

## Actuators

Module #MEC0706

### Description

A single facility can have hundreds, if not thousands, of valves to control everything from turbine operation to ventilation, to systems that ensure the safety of personnel and equipment. The valves used can range in size from less than an inch to several feet in diameter. While some of these valves are designed to be operated manually, many of them require some form of automatic or remote operation. Operators and technicians must understand the different types of actuators used to operate these valves, and how these actuators work.

### Learning Objectives

- State the purpose of a valve actuator.
- List the three basic types of actuators.
- Describe the operating principles of a pneumatic actuator.
- Describe the operating principles of an electric actuator.
- Describe the operating principles of a hydraulic actuator.





## Pipes and Pipefitting



Piping is an integral, yet often overlooked, part of an industrial facility. Pipes provide the means to transfer fluid between processes, and from one location to another for a variety of reasons. The *Pipes and Pipefitting* subject area covers codes and standards, piping support systems, insulation, materials, and manufacturing methods.



### Piping and Tubing

#### Module #MEC0601

##### Description

Piping and tubing are essential to the operation of nearly all industrial equipment, and are also found extensively throughout the home. From the pipes transporting 2,000 psi steam in a power plant to the tubing carrying the hot water from a hot water heater to the bathtub, all piping and tubing is standardized and regulated for safety.

##### Learning Objectives

- State the purpose of piping and tubing.
- Discuss schedule numbers that apply to piping.
- Describe the three classifications of tubing.
- Describe the major advantages of tubing.

### Piping Materials and Manufacturing Methods

#### Module #MEC0602

##### Description

This module introduces you to piping materials and manufacturing methods. Topics include piping materials criteria, mechanical and physical properties of metal, and pipe manufacturing methods.

##### Learning Objectives

- State the three major criteria for selecting piping materials.
- Discuss the mechanical and physical properties of metal.
- Describe the physical composition and heat-treating practices of steel.
- Describe the various pipe manufacturing methods.



## Pipe Insulation

Module #MEC0603

### Description

Controlling heat loss in a piping system is essential to maximize thermal efficiency. The proper selection of materials during design will ensure the system operates within specifications with minimum heat loss to the environment. Insulation also provides for a more temperate work environment while also protecting workers from hot piping.

### Learning Objectives

- State the purpose of insulation.
- Define thermal conductivity.
- List the different types of piping insulation.
- Describe the safety precautions associated with insulation.
- Describe how to properly install and remove insulation.

## Pipe Hangers and Supports

Module #MEC0604

### Description

As engineers plan piping systems, the support structure for these systems is designed as well. The use of pipe hangers and supports is crucial to prevent unnecessary stress on piping, while still allowing necessary movement. Properly supporting piping and piping components will extend their lifespan, by eliminating or reducing the stress on component housings.

### Learning Objectives

- State the purpose of pipe hangers and supports.
- Determine the type of pipe support by its symbol.
- Explain the proper use of pipe clamps.
- Discuss pipe hanger connecting units and supports.
- Explain the uses of pipe anchors.

## Codes and Standards

Module #MEC0605

### Description

As technology has progressed, the pressures and temperatures of liquids in piping systems have drastically increased. These pressurized liquids are capable of containing enormous amounts of stored energy, and therefore the piping carrying them needs to be regulated to ensure the personnel safety. Piping codes and standards are the first line in protecting people from these dangers, but the attention to detail and quality checks of the personnel constructing and operating these systems are crucial to safe operation.

### Learning Objectives

- Explain the necessity of a quality assurance program.
- State the difference between codes and standards.
- State the purpose of standardization.
- State the purpose of piping codes and standards.



## Lubrication Concepts

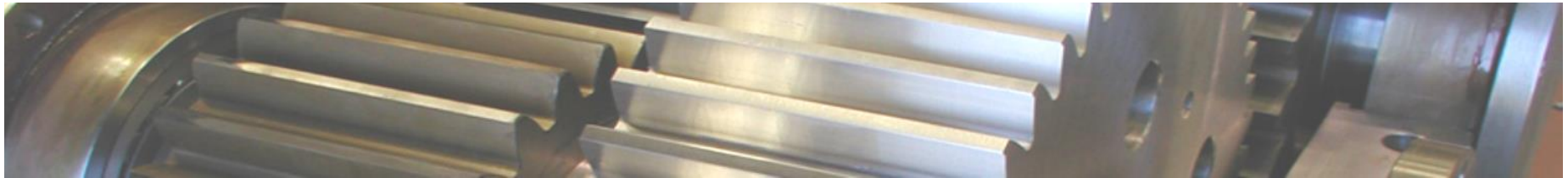

All rotating equipment creates frictional forces during normal operation. These forces can lead to catastrophic failure of the equipment unless properly lubricated. The *Lubrication Concepts* subject area explains why lubrication is vital, types of lubricants and their applications, and the principles behind it. Without lubrication, machinery will fail prematurely, causing excessive damage and production shutdowns. When equipped with the fundamental knowledge regarding lubrication, personnel are much better prepared to run a facility smoothly and react quickly in the case a problem arises.



### Principles of Lubrication

Module #MEC0801

#### Description

When any two objects are in contact, at least one type of force, friction, is acting on the contact point. Friction can cause wearing of material and generate heat. To minimize the effects of friction, a lubricant is used to partially separate the two objects.

#### Learning Objectives

- State the purpose of lubrication.
- Define sliding, rolling, and fluid friction.
- State the factors that affect lubrication.
- Explain the differences between hydro-dynamic, hydrostatic, and boundary lubrication.
- Discuss the importance of viscosity in lubricant selection.
- Describe the common methods used to lubricate bearings.

### Preventing Wear and Erosion

Module #MEC0802

#### Description

Mechanical equipment is designed to last a lifetime, in an ideal situation. As equipment is used, friction, heat, and system flow will cause wear and erosion to occur. A lubricant is used to prevent excessive damage.

#### Learning Objectives

- Describe the effects of over-lubrication and under-lubrication.
- Describe common types of wear.
- Explain the methods used to prevent wear and erosion.
- Explain why oil sampling increases equipment longevity.

## Bearing System Lubrication

Module #MEC0803

### Description

Proper lubrication is a key factor affecting a bearing's performance and longevity. Just as there are many different types of applications in which bearings are used, there are many ways of providing lubrication based on the application. To order to maintain and work on these systems, a technician must understand the various methods used.

### Learning Objectives

- Describe the common methods used to lubricate bearings.
- Explain drip feed methods of lubrication.
- Explain splash feed methods of lubrication.
- Explain force feed methods of lubrication.
- Describe grease lubricant applications.

## Lubricant Properties

Module #MEC0804

### Description

Whenever an object moves against another object, friction will be present, turning kinetic energy into heat and causing equipment to wear. Using lubricants helps to reduce this friction, allowing more work to be done for the same amount of energy input, lowering the temperatures of the materials in contact, and greatly extending the lifespan of the moving equipment.

### Learning Objectives

- Describe the various types of lubricants.
- Describe lubricating oil properties.
- Describe the properties of grease.
- Discuss the criteria used to select grease or oil.
- Explain the advantages of using additives.

## Machinery Lubrication

Module #MEC0805

### Description

From temperatures of over 1,000°F to speeds in the tens of thousands of revolutions per minute, the moving parts of industrial machinery experience colossal amounts of stress as part of their everyday operation. One of the main factors that allows equipment to operate under such extreme circumstances is the lubrication used to reduce friction between moving surfaces. Understanding the types, selection, and care of the lubrication found in an industrial facility is vital knowledge for operators and technicians.

### Learning Objectives

- Explain the purpose of lubricants used for machinery.
- Describe the types of lubricants used in machinery.
- Describe how to select a lubricant for a specific machine.
- Explain the effects of using improper lubricants on operating machinery.
- Explain the method and location to obtain valid oil samples.

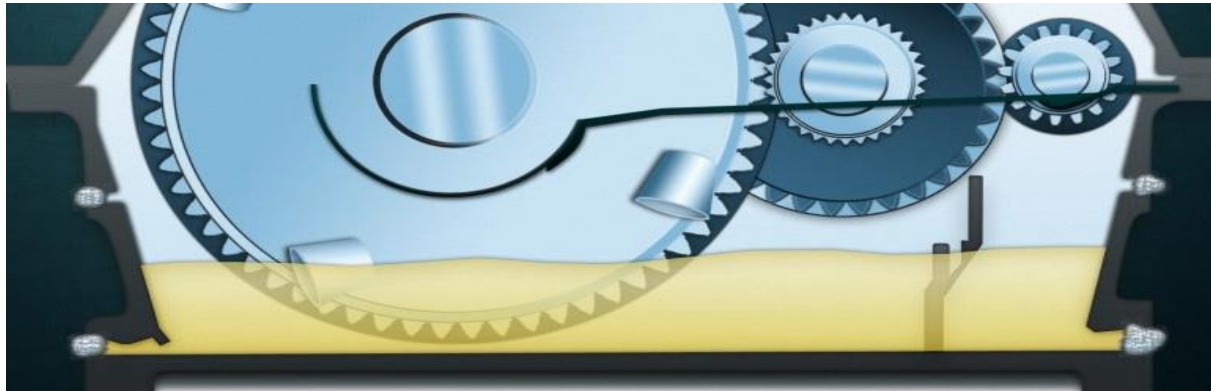

## Bearing Maintenance



Bearings play an important role in machinery. When not maintained properly, they can lead to decreased operating efficiency, noise, vibration, and even catastrophic equipment failure. A thorough understanding of bearings and proper maintenance techniques can help to ensure that mechanical equipment operates as intended for its full expected service life. The *Bearing Maintenance* subject area covers typical bearing types, their operation, and maintenance.



### Bearing Fundamentals

#### Module #MEC0901

##### Description

All rotating equipment creates radial and axial forces during normal operation. These forces can lead to catastrophic failure of the equipment unless the proper support equipment and systems are used. The most critical is the selection of bearings and lubrication systems.

##### Learning Objectives

- Explain the three basic functions of bearings.
- Identify the two basic categories of bearings.
- Describe the basic methods of lubricating bearings.
- Identify the common types of bearing failures.

### Rolling Contact Bearings I

#### Module #MEC0902

##### Description

Rolling bearings are used in almost every object, from bicycles to power generation equipment. There are many rolling bearing designs, but each is constructed to reduce rolling friction with the aid of proper lubrication techniques.

##### Learning Objectives

- Describe the basic functions of a rolling contact bearing.
- Identify the basic parts of a typical rolling contact bearing.
- Recognize common types of ball bearings.
- Recognize common types of roller bearings.
- Explain bearing lubrication.

## Rolling Contact Bearings II

Module #MEC0903

### Description

Normal maintenance of rolling contact bearings includes ensuring proper installation and lubrication methods are used. During the removal process of a bearing, the reason for a bearing failure can be analyzed and identified.

### Learning Objectives

- Explain symptoms and causes of common types of rolling contact bearing failures.
- Describe the different methods for installing rolling contact bearings.
- Describe the different methods for removing rolling contact bearings.



## Sliding Surface Bearings

Module #MEC0904

### Description

Rotating equipment, like large motors and generators, produce large amounts of force. These forces can be in a radial or axial direction to that of the shaft. A common means to support and counter these forces is through the use of journal and thrust bearings.

### Learning Objectives

- Describe common types of sliding surface bearings.
- State the purpose of journal bearings.
- State the purpose of thrust bearings.
- Discuss different lubrication methods for sliding surface bearings.



## Mechanical Transmission Systems



In an industrial facility, motors and turbines use energy to produce rotational mechanical motion. To harness this motion to perform useful work, there must be a way to transmit it to other components and machines. Three common methods of accomplishing this include gear drives, chain drives, and belt drives. The *Mechanical Transmission Systems* subject area covers these types of transmission systems, including specific applications, how each works, and basic maintenance procedures.



### Gear Drives

#### Module #MEC1001

##### Description

Gear drives and gearboxes are an essential part of equipment operation. Understanding the components, terminology, and the variety of characteristics of gears and transmission assemblies is crucial to the effective and efficient operation of these devices.

##### Learning Objectives

- State the purpose of a gear drive.
- Describe the function, operation, and characteristics of various types of gears.
- Define the terms backlash, endplay, and tooth contact.
- Explain the characteristics of gearboxes and gear set arrangements.
- Discuss gear tooth breakage, gear lubrication, scoring, and pitting.

### Gearbox Maintenance

#### Module #MEC1002

##### Description

Gearboxes and reduction drives are essential components of the industrial world. They allow smaller motors to drive larger equipment, and the ability to slow the drive speed of a motor down to a number of useful speeds that are needed for equipment operation. The proper maintenance of these gearboxes is essential to their longevity and efficiency.

##### Learning Objectives

- List precautions and methods associated with gearbox disassembly.
- Discuss precautions and methods associated with gearbox reassembly.
- Describe procedures for checking shaft endplay, backlash and tooth contact, and shaft run out.
- Identify the main components of a motor actuator that uses a worm gear set.

## Belt Drives I

Module #MEC1003

### Description

Belt drives are used to transmit power from a pulley to one or more other pulleys, and are popular due their cost-effectiveness and relative simplicity.

### Learning Objectives

- State the purpose of belt drives.
- Describe three belt selection considerations.
- Describe belt drive advantages and disadvantages.
- Explain belt tensioning.

## Belt Drives II

Module #MEC1004

### Description

There are many types of belts that are used in both industrial and commercial applications. One widely used design is the V-belt, which is commonly found in high performance engines.

### Learning Objectives

- Describe a V-belt's five interrelated components.
- Describe three different types of V-belts.
- State three advantages of poly V-belts.

## Belt Drives III

Module #MEC1005

### Description

Variable speed drives allow a single motor to drive multiple loads at different speeds. This simple design reduces the number of drives required and, therefore, maximizes available space.

### Learning Objectives

- Identify standard variable speed belt lengths and sheaves.
- Describe the three basic variable speed drives.
- Explain the use of flat belts.
- Describe three common designs of flat belts.

## Belt Drives IV

Module #MEC1006

### Description

Belt drives are used in industrial equipment to reduce noise levels and equipment vibrations. There are several designs that are used for specific purposes.

### Learning Objectives

- Describe positive drive belts.
- Describe linked V-belts.
- Describe flat belt fastening methods.

## Belt Drive Maintenance

Module #MEC1009

### Description

Maintaining a belt drive in proper working condition will maximize the life of the belts, bushings, bearings, and sheaves. In this module, common maintenance checks are discussed.

### Learning Objectives

- Describe the method for checking belt alignment.
- Explain taper lock bushing installation and removal.
- Explain the causes for shortened belt life.

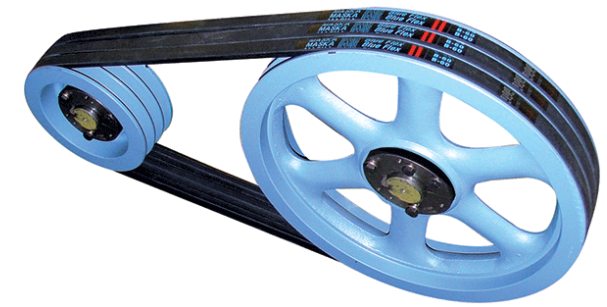

## Chain Drives I

Module #MEC1007

### Description

In an industrial facility, motors and turbines use energy to produce rotational mechanical motion. To harness this motion to perform useful work, there must be a way to transmit it to other components and machines. One method of power transmission is by using chain drives and sprockets. This module is the first of two modules focused on chain drives and their functions.

### Learning Objectives

- State the purpose of a chain drive.
- Describe the construction of roller chains, including multi-strand roller chains.
- Define the four dimensional variables of roller chains.
- State examples of leaf chain applications.
- List three recommended uses of hardened sprockets.

## Chain Drives II

Module #MEC1008

### Description

In an industrial facility, motors and turbines use energy to produce rotational mechanical motion. To harness this motion to perform useful work, there must be a way to transmit it to other components and machines. One method of power transmission is by using chain drives and sprockets. This module is the second of two modules focused on chain drives and their functions.

### Learning Objectives

- Explain the installation and removal procedures for bushings and sprockets.
- Explain how chain tension and sprocket alignment affect the operation of chain drives.
- List six conditions to look for when performing both a chain and sprocket inspection.
- Describe three methods of lubricating chain drives.
- Describe methods for link replacement.



## Rigging



Rigging can be hazardous in any setting, especially industrial ones. The *Rigging* series subject area covers the basics of rigging, including definitions, types of equipment, and procedures. Knowing rigging procedures is critical to ensure safety in an industrial facility.

### Basic Rigging I

Module #MEC1301

#### Description

In industry, the term “rigging” defines the process of moving heavy loads with ropes, hoists, and other types of specially designed tools. The term is also used to define the equipment used to lift the load. Rigging jobs consist of anything from routine lifting maneuvers to complex movements of heavy equipment and components. Regardless of the size of the job, the basic equipment and procedures are essentially the same.

#### Learning Objectives

- State the purpose of rigging.
- Describe the proper use of a simple and compound block and tackle.
- Describe the operation of chain hoists, jacks, and winches.
- Identify the types and uses of slings.
- Describe basic rigging safety precautions.

### Advanced Rigging I

Module #MEC1302

#### Description

Cranes are used in many industries, from ship-building and skyscraper construction to moving cargo containers in ports and vital equipment on oil rigs. When working around industrial cranes, one must be able to identify common rigging components and the types of cranes used, all of which are covered in this module.

#### Learning Objectives

- Identify the basic rigging equipment used in heavy lifting.
- Identify the common types and features of bridge cranes.
- Identify the common types and features of boom cranes.
- Describe the basic inspection procedures for bridge and boom cranes.

### Advanced Rigging II

Module #MEC1303

#### Description

There are many inherent dangers associated with rigging operations. By knowing the capacity and capabilities of the crane and rigging equipment, some dangers can be mitigated. Planning and following the proper steps of rigging operations will eliminate the rest of the danger. *Advanced Rigging II* takes a closer look at the operation of lifting jobs and how to ensure that they are conducted safely and efficiently.

#### Learning Objectives

- Explain how to read lifting capacity charts.
- Describe load balancing techniques commonly used during heavy lifting operations.
- Identify the basic steps involved in planning a heavy lifting job with a boom crane.
- Identify the basic steps for performing a heavy lifting job using a boom crane.

# Shaft Alignment

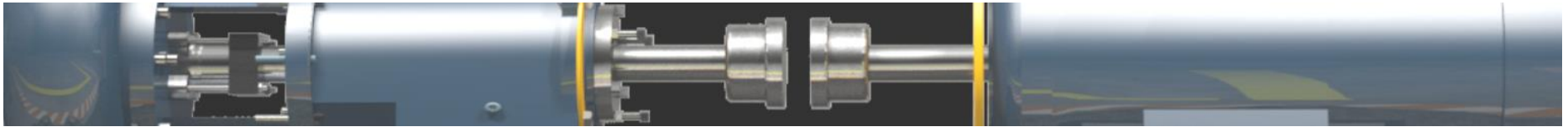

It's estimated that 50–70% of all vibration problems in machines are caused by shaft misalignment. This series, *Shaft Alignment*, address the types and effects of this common problem, along with methods to correct it. The emergence of new technologies has improved shaft alignment procedures, which is also covered in this subject area.

## Types and Effects of Shaft

### Misalignment

#### Module #MEC1101

##### Description

Shaft couplings are used extensively throughout industry on a variety of equipment to ensure the proper connection between equipment components. Proper connection and flexibility are vital to long machinery life. In this module, participants are introduced to the basics of the alignment process as well as the causes, indications, and effects of misalignment.

##### Learning Objectives

- State the goal of the alignment process.
- Name the two basic types of misalignment.
- Describe causes of misalignment.
- List four indications of misalignment.
- Explain the effects of misalignment on rotating equipment.

## Alignment Tools and Methods

#### Module #MEC1102

##### Description

The purpose of the *Alignment Tools and Methods* module is to familiarize technicians with the most common alignment methods used today. As with any method, there are potential sources of error, as well as advantages. This module points out some of the more important aspects for each method and covers visual line-up, straightedge and feeler gauge, rim and face, cross dial, reverse dial, and laser shaft alignment methods. In addition, participants learn about alignment preparation and the pre-alignment checklist.

##### Learning Objectives

- Describe the tools used in the alignment process.
- List the stages of the alignment process.
- State the pre-alignment checks.
- Describe the methods available to perform a precision alignment.

## Soft Foot and Bar Sag

#### Module #MEC1103

##### Description

*Soft foot* is defined as “a condition where the machine’s feet do not lie in the same plane as the base.” Machine frame distortion is the result of changes that occur internally or externally to the frame of the machine. This often causes a shaft deflection or movement as the hold-down bolt is tightened when a soft foot condition exists. Another common problem is indicator sag, which is the effect of gravity on a fixture. This module teaches participants to detect and correct soft foot and bar sag.

##### Learning Objectives

- Define “soft foot.”
- Describe the effects of soft foot.
- Explain how to detect and correct soft foot.
- Define “bar sag.”



## Moving the Machine

### Module #MEC1104

#### Description

Moving a machine can be the most difficult step in the entire alignment process. Alignment correction is physically moving the piece of machinery the amount prescribed by the calculations. Because the process of moving a piece of equipment is time-consuming, it is necessary that the move is based on good data calculations. This module teaches participants how to accurately perform the three stages of the alignment process.

#### Learning Objectives

- Explain the acceptable alignment methods used in each phase.
- Describe how to make accurate elevation changes on a machine.
- Describe the process of making controlled, horizontal moves on a machine.

## Rim and Face Alignment

### Module #MEC1105

#### Description

The rim and face alignment method is one of the most common alignment techniques used in industry. This method is usually used when laser alignment equipment is not available for use. This module teaches participants about the proper techniques for performing rim and face alignments.

#### Learning Objectives

- Explain the rim and face alignment method.
- Discuss the major advantages of rim and face alignment.
- Explain how the rim and face method is used to measure angular misalignment.
- Explain how the rim and face method is used to measure parallel misalignment.

## Cross and Reverse Dial Alignment

### Module #MEC1106

#### Description

The mathematical formula for calculating adjustments to properly align a shaft using the reverse double dial indicator alignment method follows a basic rise over run geometric principle. By following this principle, the alignment of machinery can be easily accomplished using the formulas. This module teaches participants how to accurately calculate and perform the cross and reverse dial alignments.

#### Learning Objectives

- Describe the cross and reverse dial alignment methods.
- Explain how graphs are used in conjunction with the cross and reverse dial methods.
- Explain how the cross and reverse dial method is used to calculate misalignment.

## Laser Alignment

### Module #MEC1107

#### Description

Advances in technology have made laser technology the standard for precision in many fields of measurement. Laser shaft alignment reduces error by guiding technicians to know the advantages of laser alignment, the safety precautions needed when using laser alignment tools, to understand how they are used to measure shaft misalignment, and how the computer interfaces with the alignment rig.

#### Learning Objectives

- Discuss safety precautions when using laser alignment tools.
- Explain how laser alignment tools are used to measure shaft misalignment.
- List the advantages of laser alignment tools.
- Describe how the computer interfaces with the alignment rig.

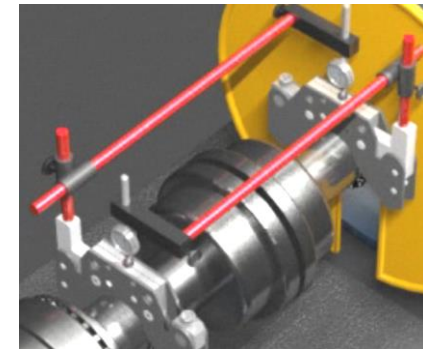

# Welding Fundamentals



Welding is a common process for joining materials using a large variety of applications. Welding occurs in several locations, from outdoors on rural farms and construction sites to inside factories and job shops. Welding processes are fairly simple to understand, and basic techniques can be learned quickly. The *Welding Fundamentals* subject area of modules covers different types of common welding and inspections.

## Introduction to Welding

Module #MEC1201

### Description

This module introduces you to welding and welding processes. Welding is a common process for joining metals using a large variety of applications. Welding occurs in several locations, from outdoors on rural farms and construction sites to inside factories and job shops. Welding processes are fairly simple to understand, and basic techniques can be learned quickly.

### Learning Objectives

- State the purpose of welding.
- State common welding terms.
- Describe the types of welded joints.
- Discuss filler metal selection.
- Identify symbols used in welding procedures.

## General Welding Safety

Module #MEC1202

### Description

This module introduces you to general welding safety. Topics included in this module are hazards associated with welding, proper PPE, and additional equipment to safely weld.

### Learning Objectives

- Discuss hazards associated with welding.
- Identify the PPE required for welding.
- Describe situations that require additional protective equipment.
- Explain the need for ventilation during welding procedures.

## Shielded Metal Arc Welding

Module #MEC1203

### Description

This module introduces you to shielded metal arc welding, or SMAW. SMAW is the most commonly used welding method, often used for repair jobs on farms, construction sites, and industrial equipment sites. This process is also preferred for outdoor welding.

### Learning Objectives

- Describe shielded metal arc welding.
- Discuss advantages and disadvantages of shielded metal arc welding.
- Discuss shielded metal arc welding equipment.
- Describe the basic shielded metal arc welding process.

## Gas Tungsten Arc Welding

Module #MEC1204

### Description

This module introduces you to gas tungsten arc welding, or GTAW. GTAW was developed to produce high quality welds on a variety of metals. GTAW requires the welder to be more skilled than other welding processes and is used in a number of work environments.

### Learning Objectives

- Describe gas tungsten arc welding.
- Discuss advantages and disadvantages of gas tungsten arc welding.
- Discuss gas tungsten arc welding equipment.
- Describe the basic gas tungsten arc welding process.

Seat Time: 30 min.

## Gas Metal Arc Welding

Module #MEC1205

### Description

This module introduces you to gas metal arc welding, or GMAW. GMAW is the most popular method of welding due to its adaptability in various industries. This type is commonly used for sheet metal work and uses a continuous wire feed to complete welds.

### Learning Objectives

- Describe gas metal arc welding.
- Discuss advantages and disadvantages of gas metal arc welding.
- Discuss gas metal arc welding equipment.
- Describe the basic gas metal arc welding process.

## Oxyacetylene Welding and Cutting

Module #MEC1206

### Description

This module introduces you to the oxyacetylene welding (OAW) and cutting process. OAW is one of the easiest forms of welding to learn and the equipment is low cost. Oxyacetylene cutting is also just as easy to learn and provides a means to cut through very thick materials. OAW and oxyacetylene cutting can be found in a number of environments including shops, construction sites, and salvage yards.

### Learning Objectives

- Explain the principles of oxyacetylene welding and cutting.
- Describe oxyacetylene welding and cutting equipment.
- Describe the basic oxyacetylene welding and cutting process.



## Brazing

Module #MEC1207

### Description

This module introduces you to brazing. Brazing provides a means to combine different materials without affecting the composition of the materials. Brazing works with temperatures above 800°F and creates bonds as strong as welded materials.

### Learning Objectives

- Describe brazing.
- List advantages and disadvantages of brazing.
- Discuss brazing equipment.
- Describe the basic brazing process.

## Weld Joint Inspection

Module #MEC1208

### Description

This module introduces you to the importance of quality welds and processes involved in analyzing welds. Topics included in this module are the effects of poor welds, causes of poor welds, and non-destructive and destructive testing methods used on welds.

### Learning Objectives

- Discuss the importance of quality welded joints.
- Describe the common types of weld failures.
- List the common methods used to test welds.

# Heat Exchangers

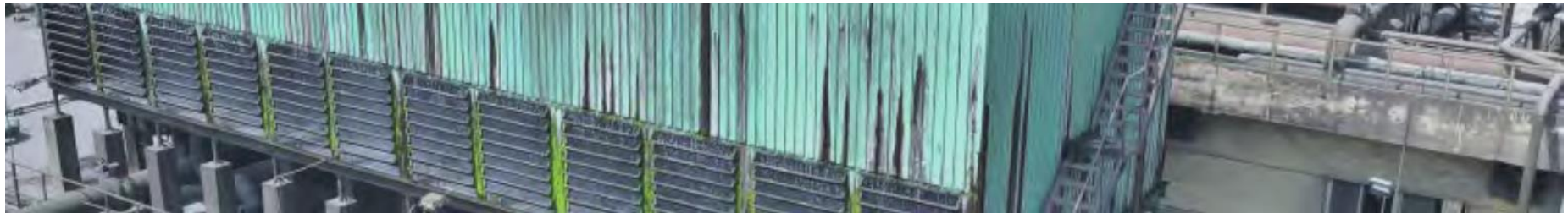

Heat exchangers are vital to everyday life and can be found in a variety of places. Wherever heat must be added or removed to a space, object, or process, some type of heat exchanger is employed. The hot water tank in your house contains an internal heat exchanger that transfers heat energy from an outside source to the water within the tank. An example of a heat exchanger removing heat is an automotive radiator, which removes heat from the engine and transfers it to the exterior.



## Heat Exchangers I

Course #MEC1301

### Description

Heat exchangers play a vital role in industrial settings as well, especially in processes that regularly require heat energy to be added or removed. An obvious beneficiary of efficient heat transfer is steam production, which occurs when heat energy is added to water. On the other hand, machinery will often require heat to be extracted from its internals to limit the damage induced by excessive heat. In both cases, and in many others, necessary heat is transferred from one medium to another via a heat exchanger in the system

### Learning Objectives

- Discuss the purposes of heat exchangers.
- Explain heat transfer theory as it applies to heat exchangers.
- Describe how the materials used in a heat exchanger's construction can affect the operation.
- List the types of fouling and corrosion to which heat exchangers are susceptible, as well as methods of mitigation.

## Heat Exchangers II

Course #MEC1302

### Description

Heat exchangers come in a variety of configurations as there is, for the most part, no “one size fits all” standard regarding what type to use in a situation or process. Therefore, understanding the differences between common types of heat exchangers, their construction, operation, and unique characteristics becomes vital not only to ensure that personnel understand what types of heat exchangers are being used, but also to ensure maintenance issues can be coordinated quickly.

### Learning Objectives

- List the methods used to classify heat exchangers.
- Discuss the construction, operation, and characteristics of shell and tube heat exchangers.
- Discuss the construction, operation, and characteristics of plate heat exchangers.
- Discuss the construction, operation, and characteristics of direct contact heat exchangers



## INSTRUMENTATION AND CONTROLS



Instrumentation and control technicians maintain the safe and efficient operation of industrial measurement and control systems. A broad knowledge of multiple disciplines is required to effectively work with and troubleshoot instrumentation systems.

The *Instrumentation and Controls* series explains the various components and systems needed to operate an efficient facility. The subject areas in this series include Intro to I&C, Process Measurement, Programmable Logic Controllers, Process Analyzers, and DCS.

Each module takes about 30 minutes to complete at an average pace.



## Intro to Instrumentation and Controls



The *Introduction to Instrumentation and Control* series covers the principles of measurement, standards, and an overview of instrumentation and control.



### Industrial Instrumentation and Control Overview

#### Module #IC0101

##### Description

Instrumentation and control technicians maintain the safe and efficient operation of industrial measurement and control systems. A broad knowledge of multiple disciplines is required to effectively work with and troubleshoot instrumentation systems; physics, chemistry, mathematics, electronics, mechanics, and control theory all need to be applied to some extent. An instrument technician must be able to synthesize and apply this knowledge to real applications.

The continued addition of new technologies adds to the challenge. For existing industrial facilities, new equipment is phased in for specific applications and legacy technologies typically remain. It is very common to find state-of-the-art instrumentation next to decades-old instruments, such as digital networks running alongside pneumatic signal tubes or microprocessor-based sensors mounted next to mercury switches.

A competent instrumentation and control technician must be comfortable working with old and new technologies, and also have a sound knowledge of measurement principles and system interactions.

##### Learning Objectives

- Describe the function of basic instrument channel components.
- Identify the major similarities and differences between an instrument channel and a control channel.
- Explain the basic operation and interaction between current and pneumatic loops.

## Principles of Measurement

Module #IC0102

### Description

The fields of measurement and instrumentation involve very specific terminology for describing instrument performance characteristics. A technician routinely encounters these terms and principles on the job, typically in the form of instrument specifications. Additionally, many of the routine tasks performed are related to instrument calibration, and are based on basic measurement principles to ensure instrument performance is in conformance to specifications.

### Learning Objectives

- Define common instrument terms and specifications.
- Explain the difference between accuracy and precision.
- Define terms used to describe the dynamic response of an instrument.

## Industrial Signal Standards

Module #IC0103

### Description

A technician may encounter a wide variety of signal standards based on the type of industrial processes and, depending on the age of the facility, possibly multiple generations of standards.

A background in common analog and digital standards provides a technician with perspective, necessary for understanding the specific standards used in a specific facility, as well as the reasons for their use.

### Learning Objectives

- Describe the common analog signals used for industrial measurement and control.
- Explain the application and basic operation of the HART Protocol.
- Identify common digital field bus standards used for industrial measurement and control.

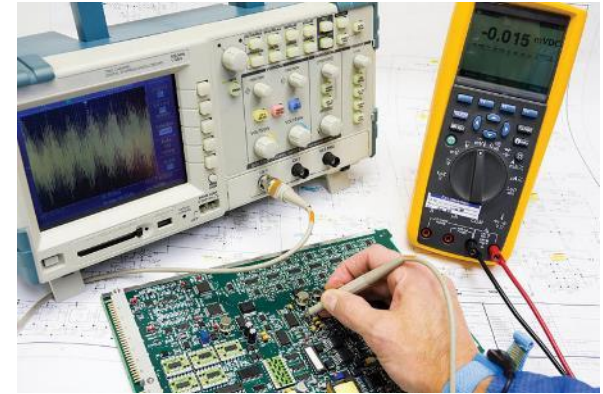

## Process Measurement

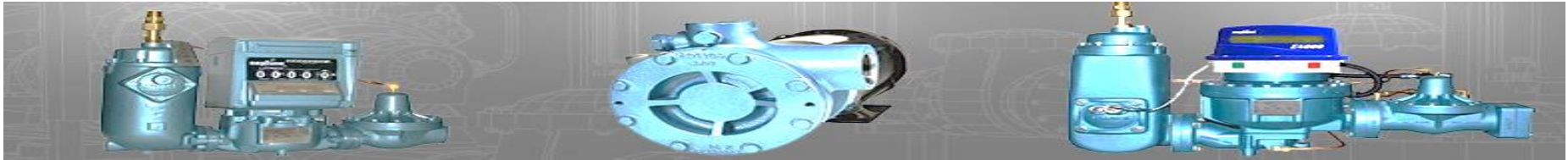

Process measurement is a critical component of ensuring that an industrial facility operates as efficiently as possible. Common processes that are measured include pressure, level, and flow. These, along with process loop tuning and the basics of valve control are covered in the *Process Measurement* subject area.

### Pressure Measurement

Module #IC0201

#### Description

Pressure is one of the fundamental parameters measured in industry. A typical industrial facility may have hundreds or even thousands of pressure meters.

#### Learning Objectives

- Identify the main units of pressure used in industry.
- Describe the most common devices used to measure pressure.
- State the operating principle for two common electronic pressure transducers.

### Level Measurement

Module #IC0202

#### Description

Liquid level measurement is critical to the safe operation of a facility. The level measurements obtained are used to monitor and control many of the processes in an industrial facility.

Numerous technologies exist that measure the liquid level in a vessel; each type uses different principles of physics to sense the level and provide output to a transmitter or transducer. The basic types of measurement devices can be broken up into two categories, direct measurement and inferred measurement.

#### Learning Objectives

- Describe the operation of the following indirect measurement level detectors:
  - Differential pressure level detectors
  - Bubblers
  - Displacers
  - Capacitance level detectors
- Describe the operation of the following mechanical direct measurement level detectors:
  - Gauge glass
  - Plumb bob
  - Float detectors

- Describe the operation of the following acoustic direct measurement level detectors:
  - Ultrasonic level detectors
  - Radar level detectors
- Explain hydrostatic head pressure.

### Introduction to Flow Measurement

Module #IC0203

#### Description

Flow measurement is one of the four fundamental parameters measured in industrial instrumentation that every technician needs to be well versed in, particularly the principles and technology used. It is also arguably the most complex with the biggest variety of types of measurement devices.

#### Learning Objectives

- Identify the common units of flow measurement.
- Describe the factors that affect fluid flow rate in a pipe.
- Identify the key characteristics of the main categories of flow meters.
- Describe the main components of a flow measurement system.

## Head Flow Meters

### Module #IC0204

#### Description

Head flow meters, or differential pressure flow meters, are the most common flow meters used in industrial facilities. It is estimated that over 50% of all fluid flow measurement applications use head flow meters.

#### Learning Objectives

- Identify the basic principles of operation for the three head flow meter variants.
- Explain the operation of a pitot tube and its related flow meters, including their advantages and disadvantages.
- Explain the operation of a venturi tube and its related flow meters, including their advantages and disadvantages.
- Identify the common orifice plates used in industry and their principle of operation.

## Linear and Mass Flow

### Module #IC0205

#### Description

Linear meters, as the name implies, are a classification of flow meters that do not require square root extraction. The two main categories of linear flow meters are:

1. Positive displacement flow meters that directly measure volumetric flow.
2. Velocity flow meters that inferentially measure volumetric flow.

Both head and linear flow meters can be used to derive mass flow rate. However, true mass flow meters are used to more accurately measure mass flow rate.

#### Learning Objectives

- Explain the basic principle of operation for common positive displacement meters.
- Explain the basic principle of operation for common velocity meters.
- Describe the principle upon which the most common type of mass flow rate meter is based.

## Temperature Measurement I

### Module #IC0206

#### Description

Temperature measurement is critical to controlling equipment, processes, and other industrial applications. From power plants to warehousing facilities, accurate temperature measurement is critical to the safe operation and control of these processes and facilities.

There are many ways to measure temperature, from the familiar liquid-filled thermometer to using resistance temperature detectors and thermocouples. This module covers the most common methods used to measure temperature.

#### Learning Objectives

- Define the term “temperature” and the units in which it is measured.
- Demonstrate the ability to convert between different temperature units.
- Explain the fundamentals of temperature measurement.
- Discuss the factors that affect temperature measurement.

## Temperature Measurement II

### Module #IC0207

#### Description

There are many ways to measure temperature. From the simple liquid-filled thermometer to the infrared pyrometer, there are a number of reliable and accurate devices used in industry to perform this critical measurement.

The type of device chosen is usually determined by factoring in required accuracy, the environment in which it is used, the temperature range over which the measurement is required, and the cost.

#### Learning Objectives

- Discuss the function and operation of:
  - Filled-system thermometers
  - Bimetallic strips
  - Pyrometers
  - Liquid-filled thermometers
  - Thermistors
- Describe the operation and use of a resistance temperature detector (RTD).
- Explain the operation of a thermocouple.

## Process Controls and Monitoring



Controlling and monitoring industrial operations using today's advanced equipment and techniques enables continuous processes to function at optimal efficiency, as well as allowing for automation of the processes. A thorough understanding of process control methods and of the monitoring required to achieve effective control will help to ensure that plant personnel are able to maintain, troubleshoot, and repair these vital plant systems.



### Process Control Fundamentals Module #IC0401

#### Description

In almost all industrial process applications, control of process variables is critical to the safe and efficient operation of the process. The most common variables controlled are pressure, level, temperature, and flow. Even though there are many different methods used to control these processes, this monitoring and control is generically called *process control*. Level, pressure, temperature, and flow are all controlled in a similar fashion. In this series of modules, level control will be used to explain the various concepts and control methods.

#### Learning Objectives

- Discuss the difference between direct- and reverse-acting controllers.
- Define common terms and symbols used in process control.
- Describe the function of self-regulated and non self-regulated processes.

### Two-Position and Proportional- Control Module #IC0402

#### Description

Control of processes is accomplished by using a number of control strategies. Two of the most common methods of control that are discussed in this module are two-position and proportional control.

#### Learning Objectives

- Explain the operation of a proportional controller.
- List common uses of a proportional controller.
- Explain the operation of a two-position controller.
- List common uses of a two-position controller.



## Integral, Derivative, and PID Control

Module #IC0403

### Description

Offset error in proportional controllers is a problem when trying to maintain a process variable at an exact value. As we saw in the *Two-Position and Proportional Control* module, one way to eliminate offset error is to manually reset the controller. The problem with manual reset is just that – it's manual. If we could automatically perform a reset every time a process supply or demand change occurred, the issue of offset error would be eliminated. We can do just that by adding integral to a controller. Integral, sometimes called *reset*, is used in conjunction with proportional control to bring the process back to set point without having an offset error. While integral eliminates the offset error, it brings its own issues, which are dealt with by adding derivative to the mix. What results is a control mode known as proportional, integral, and derivative control, commonly known as *PID control*.

### Learning Objectives

- Describe the purpose and operation of proportional and integral (PI) control.
- Explain the purpose and operation of proportional and derivative (PD) control.
- Describe the purpose and operation of proportional, integral and derivative (PID) control.

## Loop Tuning

Module #IC0404

### Description

In order for a control loop to operate as desired, it must first be tuned. Tuning a control loop is the act of adjusting the values of proportional gain, integral gain, and derivative gain such that the process responds in a manner desired by the operator. There are two major methods of tuning a control loop: open and closed loop. Almost all technicians will use the closed loop method, where data is taken from an operating loop that is online. Open loop methods are more often used on the initial startup of a system and allow engineers to collect baseline data. This module only covers closed loop tuning methods.

### Learning Objectives

- List the criteria for tuning a loop.
- Describe how to perform a loop tuning using the Ziegler Nichols method.
- Describe how to perform a loop tuning using the Notch method.
- Describe how to perform a loop tuning using the trial and error method.

## Advanced Controls Methods

Module #IC0405

### Description

While PI or PID control are the most common forms of control strategies used on control loops, there are some other control strategies that are used to solve control issues.

### Learning Objectives

- List the criteria for tuning a loop.
- Describe how to perform a loop tuning using the Ziegler Nichols method.
- Describe how to perform a loop tuning using the Notch method.
- Describe how to perform a loop tuning using the trial and error method.
- Describe the operation of feed-forward control.
- Explain the operation of cascade control.
- State the purpose of ratio control.
- List the elements which make up three element control.

## Intro to Actuators

Module #IC0406

### Description

A single facility can have hundreds, if not thousands, of valves to control everything from turbine operation to ventilation, to systems that ensure the safety of personnel and equipment. The valves used can range in size from less than an inch to several feet in diameter. While some of these valves are designed to be operated manually, many of them require some form of automatic or remote operation. Operators and technicians must understand the different types of actuators used to operate these valves, and how these actuators work.

### Learning Objectives

- State the purpose of a valve actuator.
- List the three basic types of actuators.
- Describe the purpose of the final control element in a closed loop control system.

## Actuator Principles of Operation

Module #IC0407

### Description

Actuators are available in different configurations, operated by different energy sources. *Actuator Principles of Operation* describes the three most common types and their individual operation, including pneumatic, electric, and hydraulic types.

### Learning Objectives

- Describe the operating principles of a pneumatic actuator.
- Describe the operating principles of an electric actuator.
- Describe the operating principles of a hydraulic actuator.



## Control Valves I

Module #IC0408

### Description

In June 2008 at the Goodyear plant in Houston, a heat exchanger violently ruptured due to an over-pressurization caused by the isolation of a pressure relief valve. An employee walking nearby was killed by the hurtling debris from the explosion. An understanding of the importance of these valves and their proper positioning could have prevented this incident. In this module, several types of these valves and their common components are briefly discussed, as well as the proper mounting and installation guidelines.

### Learning Objectives

- State the purpose of valves.
- List the main components of several types of valves.
- Describe the methods of valve mounting in several types of systems.

## Control Valves II

Module #IC0409

### Description

Isolation or insufficient flow can result in instantaneous over-pressurization and/or explosions; therefore, the proper positioning of isolation and throttle valves is crucial to the safe operation of any system. Gate, globe, needle, and butterfly valves are all used to stop, start, and throttle flow.

### Learning Objectives

- Describe the construction and operation of gate valves.
- Describe the construction and operation of globe valves.
- Describe the construction and operation of needle valves.
- Describe the construction and operation of butterfly valves.

## Control Valves III

Module #IC0410

### Description

Flow reversals and improper flow rates can lead to equipment failure and destruction. By understanding valve operations and ensuring proper valve orientation, these situations can be avoided. Ball valves and plug valves are used to stop, start, and throttle flow, while the check valve is used to prevent flow reversal, and the regulating valve is used to automatically adjust flow.

### Learning Objectives

- State the purpose of and describe the operation and construction of a ball valve.
- State the purpose of and describe the operation and construction of a plug valve.
- State the purpose of and describe the operation and construction of a check valve.
- State the purpose of and describe the operation and construction of a regulating valve.

### Control System Architecture

Module #IC0411

#### Description

Control loops, implemented with proportional, integral, or derivative control circuitry and simpler on/off system control points, are used within one of three architectures:

1. PLCs, or Programmable Logic Controllers, are used in smaller and simpler applications. They are the oldest of the three technologies and are often programmed with ladder-logic, relay-based tools.
2. A DCS or Distributed Control System, can be used to control an entire, large scale production facility, such as a power plant or refinery. A DCS can control separate PLC systems and have other branches they simultaneously control.
3. SCADA, or Supervisory Control and Data Acquisition, systems are used to control even larger applications, such as a series of power plants connected to a grid or multiple refineries all supplying multiple pipelines.

#### Learning Objectives

- Place a PLC system within the hierarchy of the three types of systems from most to least complex.
- Explain how a DCS ability to have PID controls implemented both within the DCS computer and the local detectors expands the range of applications this architecture can control.
- Describe how SCADA architecture is used for the largest control applications.

### Limatorque Valve Actuator

#### Fundamentals

Module #IC0412

#### Description

The first type of motor controller was the knife switch. It was a simple design and very effective, but also very dangerous. To protect workers from harm, equipment from damage, and to improve operations, a wide range of improvements have been made over the years. Today, complex Limatorque valve actuators are one of many advanced designs that allow for safer and more precise control of valve positioning.

#### Learning Objectives

- Explain the basic function of a motor-operated valve actuator.
- State the purpose of the Limatorque Valve Actuator.
- Identify the major components of a Limatorque Valve Actuator.
- Explain how to properly adjust a Limatorque Valve Actuator Limit Switch.
- Explain how to properly adjust a Limatorque Valve Actuator Torque Switch.



## Programmable Logic Controllers



Programmable Logic Controllers (PLCs) have become an integral part of the industrial environment. As a technician involved with the processes controlled by PLCs, it is important to understand their basic functionalities and capabilities. This subject area, *Programmable Logic Controllers*, covers the software and hardware used, along with the addressing and communication capabilities required for PLCs to function properly.

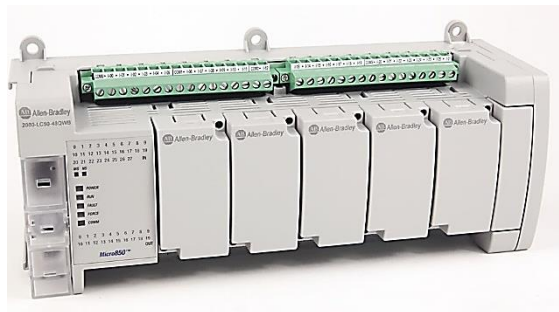

### PLC Overview

#### Module #IC0501

##### Description

Programmable logic controllers, or PLCs, are used to automate processes in industry. In the 1960s, the computerized processor replaced the relay logic control system. With the widespread use of PLCs in today's automation industry, a technician is required to have a good understanding of their operation to perform maintenance and troubleshooting procedures.

##### Learning Objectives

- List the basic components of a PLC.
- Describe the basic operation of a PLC.
- Define the three stages of a scan cycle.
- Discuss the Ladder Logic diagram of a hardwired system.

### PLC Communications

#### Module #IC0502

##### Description

In order for a PLC to effectively operate, it must be able to communicate with computers, field devices, other systems, and the various modules that make up the PLC system.

##### Learning Objectives

- Define PLC terminology as it applies to communication.
- Provide an overview of PLC communication, including communications protocols and networks.
- Identify common PLC communication configurations.

## PLC Software

Module #IC0503

### Description

Software is used in a PLC to create user projects and programs, which allow the PLC to operate. The software allows each user to create individual and unique programs for each type of PLC.

### Learning Objectives

- Identify the difference between software and firmware.
- Describe the purpose of an HMI (Human-Machine Interface).
- Discuss the basic PLC logic instructions including relays, timers, counters, and other instructions.

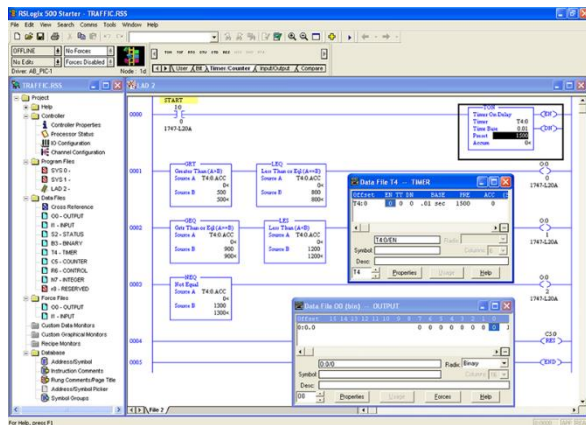

## PLC Hardware

Module #IC0504

### Description

Hardware is the physical equipment that makes up a PLC system. It includes chassis, I/O cards, processors, power supplies, communication cards and interconnecting wiring.

### Learning Objectives

- Describe the function and operation of PLC input/output modules.
- Describe the function of a Central Processing Unit.
- Describe the function and operation of a PLC power supply.

## PLC Addressing

Module #IC0505

### Description

PLCs can monitor and control thousands of individual field devices. To correctly access these devices, each device is assigned a point, or address, in the PLC. The method by which these addresses are assigned is called *addressing*.

### Learning Objectives

- Describe rack addressing rules.
- Discuss PLC addressing terminology.
- Describe the different numbering systems used by PLCs.

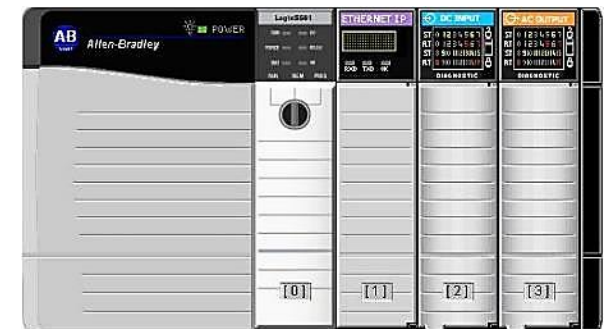



## Process Analyzers



Process analyzers are used to determine qualitative properties of a process parameter, such as impurities in water or moisture content of a gas. A technician may encounter various types of analyzers depending upon the industry and specific parameters of concern within the process. A fundamental knowledge of process analyzers will help the technician to perform his or her duties in a more efficient matter.

The *Process Analyzers* subject area covers gas chromatography, hydrogen and oxygen analyzers, and moisture analyzers.

### Introduction to Process Analyzers Module #IC0301

#### Description

The main four process variables encountered in the field of Instrumentation and Control are temperature, pressure, level and flow. However, none of these parameters provide qualitative information about the actual substance being measured and controlled.

Process analyzers are used to determine qualitative properties of a process parameter, such as impurities in water or moisture content of a gas. A technician may encounter various types of analyzers depending upon the industry and specific parameters of concern within the process.

#### Learning Objectives

- State the reasons for using process analyzers.
- Describe the components of process analyzer systems.

### Gas Chromatography I Module #IC0302

#### Description

A sample of gas may contain several different types of gases. The main goal in the gas industry is to identify and separate the one gas source into several useful, pure gas volumes. *Chromatography* is the collective term for a set of techniques used for the separation of mixtures. Gas chromatography is used for separating and analyzing compounds that can be vaporized without decomposition.

#### Learning Objectives

- Describe the history of gas chromatography.
- Discuss gas chromatography theory.
- Explain natural gas applications of gas chromatographs.

## Gas Chromatography II

Module #IC0303

### Description

Obtaining the knowledge of exact gas concentrations allows for more efficient and higher processing rates of natural gas. The gas industry relies on gas chromatography to analyze and identify the exact concentrations of the sample gas.

### Learning Objectives

- Introduce the principle elements of gas chromatography.
- Review the main factors affecting analysis.
- Describe a typical gas chromatograph operation cycle.

## Hydrogen Sulfide and Oxygen Analyzers

Module #IC0304

### Description

Both oxygen (O<sub>2</sub>) and hydrogen sulfide (H<sub>2</sub>S) are present in varying concentrations in unrefined natural gas. Although most of the oxygen and hydrogen sulfide are removed during the refining process, trace amounts still remain. These trace remnants and their levels must be monitored and controlled to ensure gas quality standards, as well as prevent corrosion of pipeline materials and damage to handling and utilization equipment.

This module serves as an introduction to the equipment and methods used in determining the presence and concentrations of oxygen and hydrogen sulfide in a gas sample.

### Learning Objectives

- State the purpose of hydrogen sulfide analyzers and give examples.
- State the purpose of oxygen analyzers and give examples.



## Moisture Analyzers

Module #IC0305

### Description

There are many applications in which trace moisture measurements are necessary for manufacturing and process quality assurance. Some examples are:

- Moisture in percentage amounts is monitored as a specification in commercial food production.
- Trace moisture in solids must be controlled for plastics, pharmaceuticals and heat treatment processes.
- Trace moisture must be measured and controlled in dry air, hydrocarbon processing, pure semiconductor gases, bulk pure gases, dielectric gases, such as those in transformers and power plants, and natural gas pipeline transportation.

This module serves as an introduction to some of the equipment and methods used to measure the amount of moisture in a gas sample.

### Learning Objectives

- Summarize the purpose of water vapor dew point analyzers and give examples.
- Describe the basic operation of a chilled mirror hygrometer.

## Density Analyzers

### Module #IC0306

#### Description

*Density* is one of the fundamental physical properties required when the composition of a product sample is being determined in a process industry. Product density measurements are needed for:

- Process monitoring and control
- Custody transfers

#### Learning Objectives

- Discuss the theory and application of density analyzers.
- List the factors that influence density measurements.
- Explain the operation principles for a liquid density analyzer.
- Explain the operation principles for a gas density analyzer.

## Dew Point Analyzers

### Module #IC0307

#### Description

*Dew point* is the specific temperature at which condensation begins. Process gas analyzers for dew point/moisture content perform an important role in operations. They are used to:

- Monitor for damaging levels of entrained liquids to protect piping and equipment.
- Correct for entrained water to calculate amount of gas during custody transfers.

#### Learning Objectives

- Explain dew point and the importance of monitoring moisture content of gas streams.
- Describe the aluminum oxide capacity method of dew point measurement.
- Discuss the quartz-crystal method of dew point measurement.
- Describe the chilled mirror method of dew point measurement.



## Hydrogen Sulfide Gas Analyzers

### Module #IC0308

#### Description

Hydrogen sulfide, or H<sub>2</sub>S, exists in many natural gas and oil fields throughout the world. H<sub>2</sub>S is both highly toxic and corrosive, and must be reduced to acceptable levels to:

- Preserve public safety.
- Reduce corrosion in pipelines and related equipment.
- Ensure proper custody transfer agreements.
- Control the odor of the gas.

#### Learning Objectives

- Explain the importance of online H<sub>2</sub>S monitoring.
- Discuss the characteristics of H<sub>2</sub>S.
- Describe the operation of a photometric continuous on-line H<sub>2</sub>S analyzer system.
- Explain the hardware components of a photometric continuous on-line H<sub>2</sub>S analyzer system.

## Introduction to Spectrometry

### Module #IC0309

#### Description

Spectrometry is an analysis technique that measures the electromagnetic radiation emitted, absorbed, or scattered by a sample in order to study, identify, and quantify its composition and structure. Spectrometric measurements can be:

- Quantitative: Determining how much of a component is present.
- Qualitative: Identifying what components are found in a sample.

#### Learning Objectives

- Explain the theory of spectrometry.
- Describe an optical spectrometer.
- Discuss how ultraviolet/visible, infrared, x-ray, and mass spectrometers operate.

## Infrared Spectrometry

Module #IC0310

### Description

Infrared (IR) spectrometers are commonly used to determine the concentration of sample components, like carbon dioxide and carbon monoxide, as well as that of common functional groups like the oxygen-hydrogen bond in liquids and gases.

### Learning Objectives

- Describe the working principles of IR spectrometry.
- Explain the measurement principles of IR spectrometry.
- Describe sample conditioning and safety for IR spectrometry.

## Mass Spectrometry

Module #IC0311

### Description

Mass spectrometry is an analysis technique that is used to determine the composition of process samples. Advances in technology have led to the development of versatile, easy-to-use mass spectrometers. Mass spectrometers are commonly used in, among others, the oil and gas, environmental, pharmaceutical, and food processing industries.

### Learning Objectives

- Describe the working principles of mass spectrometers.
- Explain the measurement principles of mass spectrometers.
- Describe the main hardware components of mass spectrometers.
- Describe sample conditioning and safety for mass spectrometers.

## Process Analyzer Detectors

Module #IC0312

### Description

Gas analyzer detectors are used to identify specific types of compounds within a given gas sample. Knowing the concentration of these various compounds is vital to the safe and efficient operation of plant systems.

### Learning Objectives

- Discuss continuous gas analyzer types.
- Explain the thermal conductivity detector continuous gas monitoring
- Describe the flame ionization detector continuous gas monitoring
- Explain the flame photometer detector continuous gas monitoring



## Residual Chlorine Analyzers

Module #IC0313

### Description

Chlorination treatment is widely used for the disinfection of potable water supplies and industrial water systems. Residual chlorine levels are monitored in:

- Influent water for proper disinfection levels, enabling operators to optimize processing.
- Effluent water to ensure they are within acceptable limits prior to discharge.

### Learning Objectives

- Discuss residual chlorine.
- Describe the DPD measurement method for total residual chlorine.
- Explain the amperometric measurement method for free residual chlorine.
- Explain the amperometric measurement method for total residual chlorine.

## Turbidity Analyzers

Module #IC0314

### Description

Turbidity is used as a measure of the clarity or cloudiness of a liquid. It gives a good indication of the appearance of water in an aesthetic sense, but more importantly, it is an indicator of the amount of suspended material.

### Learning Objectives

- Explain the principles of turbidity measurement.
- Describe the absorption method for turbidity measurements.
- Explain the 90-degree scattered light method for turbidity measurements.
- Describe the surface-scattering method for turbidity measurements.

## UV-VIS Spectrometry

Module #IC0315

### Description

Ultraviolet-Visible (UV-VIS) spectrometry is used to measure the concentration of components in liquids and gases. Visible light can be seen by the human eye, while ultraviolet (UV) light cannot.

### Learning Objectives

- Describe the working principles of Ultraviolet-Visible, or UV-VIS, spectrometry.
- Describe the UV-VIS photodiode array, or PDA, spectrometer.
- Describe the UV differential method spectrometer.
- Explain sample conditioning and safety of UV-VIS spectrometry.

## pH Analyzers

Module #IC0316

### Description

Whether it be the drinking water produced by a municipal water treatment plant or the feedwater that becomes the steam used to spin a power plant turbine generator, the ability to control the pH of a fluid is vital to many industrial processes. To control and optimize the pH of a process fluid, it is important to first understand what pH is, how it can be measured, and how it can have an effect on different processes.

### Learning Objectives

- Define pH and the pH scale.
- Explain the theory of operation of pH measuring instruments.
- Describe industrial applications where pH measurement is important.

## Total Organic Carbon Analyzers

Module #IC0317

### Description

Total Organic Carbon, or TOC, analyzers provide important water analysis by detecting organic compounds in process water. TOC levels are monitored in:

- Influent water for the early detection of high organic loads, enabling operators to optimize processing.
- Effluent water to help control the amount of organics present before discharging wastewater.

### Learning Objectives

- Explain total organic carbon measurement principles.
- Describe the UV persulphate measurement method for total organic carbon.
- Explain the catalytic oxidation measurement method for total organic carbon.
- Explain the thermal oxidation measurement method for total organic carbon.



## Introduction to Chromatography

Module #IC0318

### Description

*Chromatography* is an analytical method used to separate, identify, and quantify substances of a product into its chemical components for identification. For example, a gas chromatograph can be used to identify the amount of sulphur present in crude oil or the amount of each chemical component in natural gas.

### Learning Objectives

- Explain the fundamentals of chromatography.
- Explain the principle operation of gas chromatography.
- Explain chromatograph components.
- Identify the main difference between gas and liquid chromatography.



## Titration Basics

Module #IC0319

### Description

*Titration* is a common method of chemical analysis that is used to determine the unknown concentration of an analyte, the substance being analyzed, in a solution. There are many types of titrations with different procedures and goals.

### Learning Objectives

- Explain titration.
- Explain how to calculate the concentration of an analyte in solution.
- Describe the different types of titration.
- Describe how the endpoint is determined and the methods used to detect the endpoint.
- Explain titration methods.
- List analyzer components.

## X-Ray Spectrometry

Module #IC0620

### Description

X-ray spectrometry is an analysis technique that measures the radiation emitted from a sample. Each element is composed of specific atoms. X-ray spectrometry identifies the types of atoms found in a sample, therefore identifying the elements that are present. Advances in technology have led to the development of compact X-ray spectrometers, ranging from in-line and table-top equipment to small hand-held devices.

### Learning Objectives

- Discuss the working principles of X-ray spectrometry.
- Explain measurement principles for X-ray spectrometry.
- Describe safety concerns for X-ray spectrometry.



## Distributed Control Systems (DCS)



Control system architecture can range from simple local control to highly redundant distributed control system, or DCS. The complexity of a DCS requires that personnel understand typical system architecture, communication strategies, interface strategies, and system reliability, which are covered in this subject area, DCS.

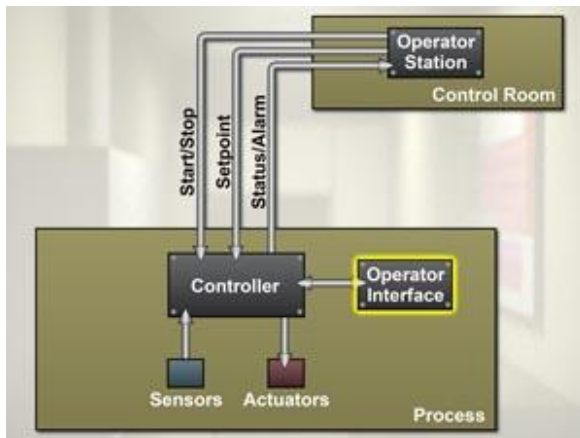

### Data Acquisition and Control System Architecture

#### Module #IC0601

##### Description

Control system architecture can range from simple local control to highly redundant distributed control. Supervisory control and data acquisition, or SCADA, systems, by definition, apply to facilities that are large enough that a central control system is necessary. Reliability criteria for C4ISR facilities dictate the application of redundant or distributed central control systems.

##### Learning Objectives

- Describe control system architecture types.
- Discuss the benefits of distributed control system architecture systems.
- Discuss the use of programmable logic controllers.
- Identify the recommended configurations of SCADA systems.

### Data Acquisition Communications Strategies

#### Module #IC0602

##### Description

Communication networks may be used in supervisory control and data acquisition, or SCADA, systems to pass data between field devices and programmable logic controllers, or PLCs. They can also be used between different PLCs or between PLCs and personal computers that are used for operator interface, data processing and storage, or management information.

##### Learning Objectives

- Describe the methods of communication for electronic devices.
- Identify the types of physical media used for communication.
- Describe communication protocols.
- Identify the network topologies used for communication.
- Explain when redundancy is required for SCADA systems.

## Data Acquisition System Reliability

Module #IC0604

### Description

Supervisory control and data acquisition, or SCADA, systems require many design considerations to obtain a high level of reliability. These considerations include everything from the power supply to the individual components that make up the whole system.

### Learning Objectives

- Describe reliability criteria for SCADA systems.
- Identify redundancy terminology.
- Discuss component and system reliability.
- Identify the possible power supplies for SCADA systems.

## Operator Interface Strategies

Module #IC0603

### Description

Operator interfaces are referred to as human machine interfaces, or HMIs. For supervisory control and data acquisition, or SCADA, systems, HMIs provide the functions of status indication, alarm reporting, operator intervention in control action, and data storage and programming.

### Learning Objectives

- Describe the different levels of HMIs.
- Discuss the effects of human factors on SCADA systems.

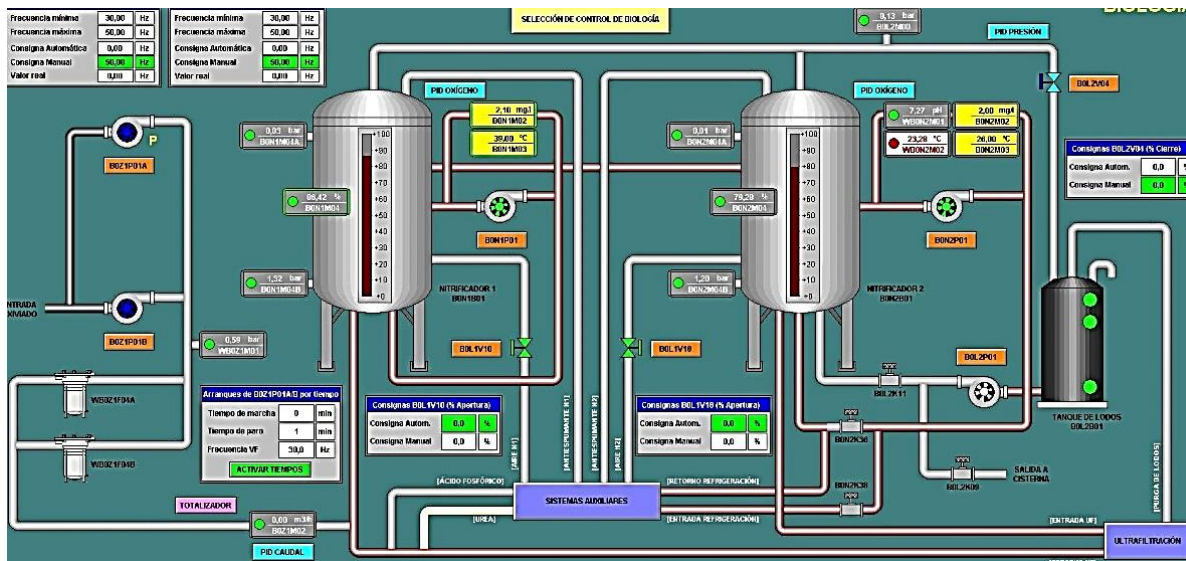

## ELECTRICAL



An understanding of basic electrical systems is vital to be able to work safely and efficiently in an industrial setting. The *Electrical* series of modules covers the fundamentals of electrical systems and components in an industrial facility.

The *Electrical* series will familiarize the learner with important aspects of modern electrical control and distribution. Subject areas include Circuit Protection, Motors and Motor Control, Transformers, and Variable Frequency Drives.

Each module takes about 30 minutes to complete at an average pace.

## Circuit Protection



Working with electricity is inherently dangerous, thus circuit breakers and protective relays are required to protect personnel. The *Circuit Protection* subject area covers both circuit breakers and protective relays, their functions, types, and methods of operation.

### Basic Relaying I

Module #ELE0201

#### Description

Large electrical systems rely on protective relays to continuously monitor critical equipment throughout a facility. The sensing quantities and operating characteristics for relays are described in this module.

#### Learning Objectives

- Describe the attributes of a protective relay system.
- Discuss the five functional categories of relays.
- Describe the basic sensing quantities for relays.
- Describe the operating characteristics of relays.

### Basic Relaying II

Module #ELE0202

#### Description

Protective relays have a variety of settings based on the level of protection required and the time for actuation of the relay. This module explains the necessary balance of time delay characteristics and zones of protection.

#### Learning Objectives

- Describe the time delay characteristics of relays including definite time, inverse, very inverse, and extremely inverse characteristics.
- Describe zones of protection.
- Describe electromagnetic induction devices including the induction disk-type and induction cup-type relays.
- Describe electromagnetic attraction units including the hinged armature-type and plunger-type relays.

### Advanced Circuit Breakers

Module #ELE0203

#### Description

This module covers the general principles of Low Voltage (LV) and Medium Voltage (MV) circuit breakers, the main functions of LV and MV circuit breakers, the types of LV and MV circuit breakers and their methods of operation.

#### Learning Objectives

- Identify the differences between LV circuit breakers and LV power and MV circuit breakers.
- Describe the main features of a circuit breaker.
- Describe the trip-free and anti-pumping operation of circuit breakers.
- Describe the various time delay settings of circuit breakers.
- Describe the various types of circuit breakers.



## Motors and Motor Control



The electric motor is the workhorse of the modern industry. Its functions are almost unlimited. A thorough understanding of the function of the various components of a motor control center is desirable from both a maintenance and a troubleshooting standpoint. Properly maintained motors and motor control centers ensure a minimum of downtime for unscheduled repairs, increase productivity, and contribute to a safer working environment.

The *Motor and Motor Controls* subject area covers many aspects of these workhorses, including direct and alternating current configurations, protection, motor starters, and basic electrical and control circuitry.

### Alternating Current Motors

#### Module #ELE0101

##### Description

AC motors are widely used throughout industrial facilities and commercial industries. This module will introduce AC motor theory and describe the construction and operations of the most commonly used AC motors.

##### Learning Objectives

- Explain AC motor theory.
- Describe the construction and operating characteristics of induction motors.
- Describe the construction and operating characteristics of synchronous motors.
- Describe the construction and operating characteristics of wound rotor motors.

### Motor Control Fundamentals

#### Module #ELE0102

##### Description

Most industrial sized motors require complex equipment for the operational control. This module describes the operation and benefits of the different motor controllers.

##### Learning Objectives

- Describe the common types of motor controller enclosures.
- Describe manual control, semiautomatic control, and automatic control.
- Describe the types of magnetic contactors.
- Explain the operation and variations of magnetic contactors.

## Motor Protection and Nameplate Data

Module #ELE0103

### Description

All motors are required to display the operational limitations and protective limits. This information is crucial in establishing a well-balanced electrical system, and aid in troubleshooting.

### Learning Objectives

- Describe common types of motor enclosures.
- Explain the nameplate data for a typical motor.
- Describe typical methods of motor protection.

## Control Circuit Diagrams

Module #ELE0104

### Description

Large facilities may have hundreds if not thousands of electrical devices that work together to accomplish a single task, as in a conveyor belt system within a distribution center. These devices use sequencing for this complex task, known as *control circuits*. To easily understand and analyze how a particular circuit operates, the circuit diagrams are used.

### Learning Objectives

- Explain sequence control.
- Explain the operation of motor control center's power supplies.
- Describe the proper use of the motor control center's single line diagrams, including diagram analysis and standard device numbers.

## Motor Starters

Module #ELE0105

### Description

The selection of the motor starter circuit is critical for the safe and cost effective starting of large electrical motors. This module describes the types of starters used and the purpose for each design.

### Learning Objectives

- Describe the operation of full voltage and reduced voltage starters.
- Describe the operation of wye-delta and part winding starters.
- Describe the operation of speed and consequent pole controllers.
- Explain the importance of control power.

## Direct Current Motors

Module #ELE0106

### Description

Direct current, or DC, motors are used in everything from remote control airplanes to electric cars. They operate off of a simple principle known as *Lorentz force*. This principle is that a current-carrying conductor in a magnetic field experiences a torque.

### Learning Objectives

- Describe the operating principles for DC motors.
- Describe the design and characteristics of a DC shunt, series, and compound motor.

## Electrical Diagrams

Module #ELE0107

### Description

An electrical circuit for motors may contain thousands of wires with dozens of inputs and outputs. This module provides the necessary understanding of control devices and the common electrical symbols used for electrical diagrams.

### Learning Objectives

- Describe the various circuit diagrams.
- Identify control devices and their diagram symbols.
- Describe mechanical, pushbutton, and auxiliary contact interlocking.



# Transformers



The *Transformers* subject area covers power transformers and instrument transformers. The *Power Transformer* modules discuss various designs and tests, while the *Instrument Transformer* module explains industrial types and designs of transformers.

## Transformers

### Module #ELE0301

#### Description

There are many types and designs of transformers used in industrial facilities. Power and distribution transformers provide power for loads within the facility, while instrumentation transformers provide power for the monitoring of parameters including those of the power and distribution transformers.

#### Learning Objectives

- State the purpose of instrument transformers.
- Explain burden and saturation.
- Describe the characteristics and functions of different types of current transformers.
- Describe coupling capacitor potential transformers.
- Describe some of the transformer monitoring and protection features.

## Power Transformers I

### Module #ELE0302

#### Description

Power transformers are widely used in power generation plants and distribution substations. The information that is required on the transformer nameplate distinguishes amongst the many different designs available. This module describes the different designs and the nameplate information.

#### Learning Objectives

- Describe the different types of power transformers.
- Describe the information found on transformer nameplates.

## Power Transformers II

### Module #ELE0303

#### Description

Power transformers require precise testing upon installation and periodically to ensure proper operation. This module introduces some common tests and the purpose behind each.

#### Learning Objectives

- Describe the construction of a power transformer.
- Describe the basic testing requirements for power transformers.



# Variable Frequency Drives



The use of variable frequency drives, or VFDs, allows exact speed control by controlling the voltage or the current of a motor. Understanding the fundamentals of VFDs, along with installation, programming, and troubleshooting is critical to efficient operation. The *Variable Frequency Drive* subject area covers these items.

## VFD Fundamentals

### Module #ELE0401

#### Description

Variable frequency drives, or VFDs, are widely used to provide variable speed operation to AC motors that normally operate at a standard speed. This module explains the functional operation, methods of interfacing, and the advantages and disadvantages of the various types of VFDs.

#### Learning Objectives

- Describe the functions and operations of an AC drive.
- Describe the common types of interface methods.
- Explain the advantages and disadvantages of each type of variable voltage, constant voltage, and current source AC drives.

## VFD Installation and Programming

### Module #ELE0402

#### Description

While there are many manufacturers for VFDs, the installation and initial programming is critical. This module introduces the learner to some standard requirements while reinforcing the use of the manufacturers' provided manuals.

#### Learning Objectives

- Describe the requirements for installing a VFD.
- Describe the startup sequence of a VFD.
- Describe the programmable parameters of a VFD.

## VFD Troubleshooting

### Module #ELE0403

#### Description

Troubleshooting of VFDs can be very complex and time consuming. This module provides the common fault and alarm indications, types, and troubleshooting methods.

#### Learning Objectives

- Describe the common fault and alarm indications.
- Describe the common types of faults and alarms.
- Explain the use of troubleshooting tables.





## POWER GENERATION

The *Power Generation* series introduces the combined cycle process as well as a basic through advanced understanding of the systems and major equipment that make up a combined cycle power plant.

Combined cycle plants generate power through an assembly of heat engines working off of one source of heat. This enables a combustion turbine facility to generate 50% more power output from the same amount of fuel that would be burned in a simple cycle combustion turbine. To do this, they incorporate many components that work together to produce energy.

This subject area reviews major plant components and auxiliary systems, combined cycle configurations, the Brayton and Rankine cycles, turbines and condensers, and the operation of HRSGs.

This series consists of 47 modules. Each module takes about 30 minutes to complete at an average pace.



## Combined Cycle Fundamentals



The *Combined Cycle Fundamentals* subject area explains the basics of a combined cycle power plant. Included is information about major components and the overall theory of operation.



### Introduction to Power Plants

#### Module #COM0101

##### Description

We depend on electricity for many tasks each day, from lighting, heating, and cooling our homes, to powering our televisions and computers. Despite its great importance in our daily lives, few of us stop to think what life would be like without electricity.

##### Learning Objectives

- Describe the historical overview of electric utilities.
- Describe the national electric power grid.
- Explain the process of how electricity is generated and distributed to customers.
- Define and explain the different types of generation plants and state the advantages and disadvantages of each.
- Identify types of renewable sources and explain the advantages and disadvantages of each type.

### Combined Cycle Plant Overview

#### Module #COM0102

##### Description

Combined cycle plants generate power through an assembly of heat engines working off of one source of heat. The major components that make up a combined cycle plant include the gas turbine, heat recovery steam generator, steam turbine, and various other components making up the balance of plant. This module introduces these components and describes their purposes and theory of operation. In addition, the module provides an overview of the auxiliary systems found in combined cycle plants.

##### Learning Objectives

- State the purpose of a combine cycle plant.
- Explain the function of the following combined cycle plant components:
  - Gas Turbine
  - Heat Recovery Steam Generator
  - Steam Turbine
  - Balance of Plant Components

- Explain the theory of operation for the following components:
  - Gas Turbine
  - Heat Recovery Steam Generator
  - Steam Turbine
- Identify the major auxiliary systems for combined cycle plants.

## Combined Cycle Theory of Operations

Module #COM0103

### Description

Combined cycle technology enables a combustion turbine facility to generate 50% more power output from the same amount of fuel that would be burned in a simple cycle combustion turbine. This module provides an overview of the different configurations for a combined cycle plant, as well as the two thermodynamic cycles that form this combination.

### Learning Objectives

- Describe the different configurations for a combined cycle plant.
- Describe the gas turbine's Brayton cycle.
- Describe the steam system's Rankine cycle.

## Combined Cycle Major Components

Module #COM0104

### Description

Combined cycle plants incorporate many components that work together to produce energy. This module provides an overview of the four major components that make up a combined cycle plant, including the gas turbine, HRSG, steam turbine, and condenser. Additionally, the module describes the operation of each of these components.

### Learning Objectives

- Describe the operation of a gas turbine.
- Describe the operation of an HRSG.
- Describe the operation of a steam turbine.
- Describe the operation of a condenser.

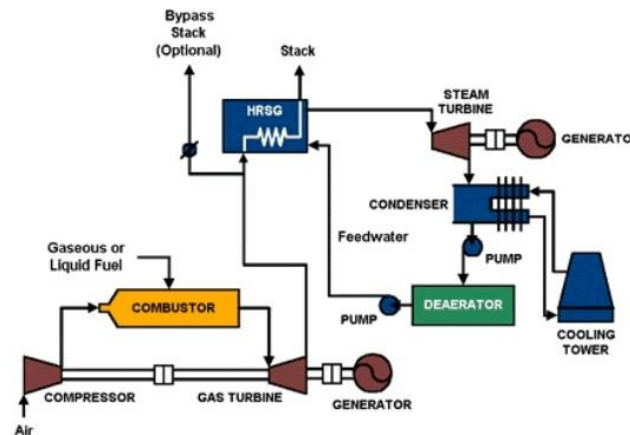

## Gas Turbine

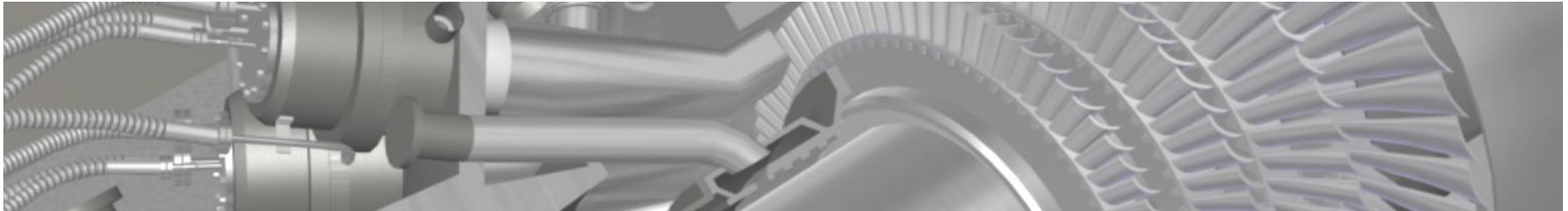

Gas turbines convert chemical energy stored in fuel into rotational mechanical work. A portion of this rotational mechanical work is used to generate electrical power. The gas turbine is a vital part of a combined cycle plant.

The *Gas Turbine* subject area covers air inlet systems, controls and monitoring, fuel systems, lubrication, bearings, and the construction of the turbine itself.

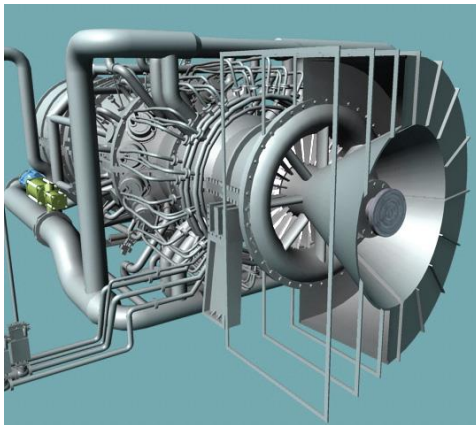

### Gas Turbine Basics

#### Module #COM0201

##### Description

Whether for the production of power and heat or the transport of oil and gas, gas turbines are widely used for combined cycle applications. The *Gas Turbine Basics* module introduces the basic theory of operation for gas turbines, along with the common terminology used to describe their operation. Additionally, this module provides an overview of the major components of a gas turbine.

##### Learning Objectives

- State the purpose of gas turbines.
- Define common terminology.
- Describe the major components.
- Explain the theory of operation.

### Air Inlet Systems

#### Module #COM0202

##### Description

Effective management of gas turbine inlet air quality and temperature is often the most economical option to increase power, reduce heat rate, and extend component life. This module provides an overview of air inlet systems, including common terminology, the purpose of major system components, and the different types of cooling systems.

##### Learning Objectives

- Define common terminology.
- Describe the major components.
- State the purpose of evaporative cooling systems, chilling systems, and fogging systems.
- Describe the flow path of air through the system.

## Compressor Section

Module #COM0203

### Description

This module provides an overview of the compressor section of a gas turbine, including its basic characteristics, theory of operation, and major components. Additionally, the module introduces inlet air heating systems and cooling air systems and explains their purpose.

### Learning Objectives

- State the purpose of the compressor section.
- Define common terminology.
- Describe the major components.
- Explain the theory of operation.
- State the purpose of compressor bleed valves, inlet air heating systems, and turbine cooling air systems

## Combustion Section

Module #COM0204

### Description

This module provides an overview of the combustion section of a gas turbine, including its basic characteristics, theory of operation, and major components. Additionally, the module describes the function and major components of the combustion section's fuel system.

### Learning Objectives

- State the purpose of the combustion section.
- Define common terminology.
- Describe the major components.
- Explain the theory of operation.

## Turbine Section

Module #COM0205

### Description

This module provides an introduction and the common terminology associated with the turbine sections. This module also covers the major components of a turbine section including the exhaust and the theory of operation.

### Learning Objectives

- State the purpose of the turbine section.
- Define common terminology.
- Describe the major components.
- Explain the theory of operation.

## Gas Turbine Bearings

Module #COM0206

### Description

Thrust and journal bearings are a critical part of the turbine section's function. This module provides an overview of the purpose of bearings within a combined cycle system, as well as common terminology that applies to bearings. Additionally, this module explains the theory of operation for the different types of bearings.

### Learning Objectives

- State the purpose of gas turbine bearings.
- Define common terminology.
- Describe the major types of gas turbine bearings.
- Explain the operation of different types of bearings.

## Starting Package

Module #COM0207

### Description

This module introduces various types of starting packages used for gas turbines, including motor-operated, air- or hydraulic-operated, and static frequency control system or load commutated inverter (LCI). The module also describes the theory of operation for these packages and major starting package components.

### Learning Objectives

- State the purpose of the starting package.
- Define common terminology related to the starting package.
- Describe the major components of the starting package.
- Explain the theory of operation for the starting package.

## Fuel Systems

Module #COM0208

### Description

This module provides an overview of the different types of fuel systems used within the gas turbine, including the fuel gas system, fuel oil system, and water injection system. In addition, the module explains the purpose of each of these systems and describes their major components.

### Learning Objectives

- State the purpose of fuel gas systems.
- Describe the major components of fuel gas systems.
- State the purpose of fuel oil systems.
- Describe the major components of fuel oil systems.

## Combustion Controls and Continuous Emissions Monitoring

Module #COM2009

### Description

This module provides an overview of the different types of combustion control systems used for gas turbines, including related terminology, theory of operation, and the major components that make up these systems.

### Learning Objectives

- State the purpose of combustion control systems.
- Define common terminology.
- Describe the major types.
- Explain the theory of operation.
- State the purpose of continuous emissions monitoring systems.

## Gas Turbine Lubricating and Lift Oil Systems

Module #COM0210

### Description

This module introduces the lubricating oil, hydraulic oil, and lift oil systems for the gas turbine, including common terminology related to the systems. Additionally, the module identifies and explains the major components that make up these three systems.

### Learning Objectives

- State the purpose of gas turbine lubricating and lift oil systems.
- Define common terminology.
- Describe the major components.
- Explain the theory of operation.

## Gas Turbine Hydraulic Oil Systems

Module #COM2011

### Description

This module introduces the lubricating oil, hydraulic oil, and lift oil systems for the gas turbine, including common terminology related to the systems. Additionally, the module identifies and explains the major components that make up these three systems.

### Learning Objectives

- State the purpose of gas turbine hydraulic oil systems.
- Define common terminology.
- Describe the major components.
- Explain the theory of operation.

## Fuel Support Systems

Module #COM2013

### Description

This module provides an overview of fuel support systems, including its purpose and the common terminology that applies to the system. In addition, the module explains the theory of operation for fuel support systems and describes the purpose of the major components found within the system.

### Learning Objectives

- State the purpose of fuel support systems.
- Describe the major components of atomizing air systems.
- Explain the theory of operation for atomizing air systems.
- Describe the major components of water injection systems.
- Explain the theory of operation for water injection systems.

## Water Wash Systems

Module #COM0212

### Description

The water wash system is used during the cleaning process to improve gas turbine power output and efficiency. This module introduces the water wash system, including common terminology, as well as describes the major components within the system.

### Learning Objectives

- State the purpose of the water wash system.
- Define common terminology related to the water wash system.
- Describe the major components of the water wash system.
- Explain the theory of the water wash system.





## Heat Recovery Steam Generators



The power generation of a combined cycle plant is split into two major parts: the gas turbine and the steam turbine. The heat recovery steam generator, or HRSG, is what makes the operation of the steam turbine possible.

This subject area, *Heat Recovery Steam Generators*, covers the basics of the HRSG, HRSG drum and blowdown systems, duct burners, selective catalytic reduction systems, and related chemistry.



### HRSG Basics Module #COM0301

#### Description

An HRSG's basic function is to remove useful energy in waste heat from a gas turbine, or from some other combustion process, and transform it into steam energy. This steam energy can then be used to drive a steam turbine, produce electricity, or supply steam to a host for other purposes. This module provides an overview of HRSG operation, which is a critical factor in achieving high thermal efficiencies in a combined cycle plant.

#### Learning Objectives

- State the purpose of Heat Recovery Steam Generators.
- Define common terminology.
- Define the major components.
- Explain the theory of operation.

### HRSG Drum and Blowdown Systems Module #COM0302

#### Description

The HRSG blowdown system is instrumental in ensuring the boiler water chemistry is kept within specifications with regard to dissolved and suspended solids, pH, conductivity, and silica content. This module introduces the blowdown system, explains its theory of operation, and describes the major components that make up the system.

#### Learning Objectives

- State the purpose of heat recovery steam generator drums.
- State the purpose of blowdown systems.
- Define common terminology.
- Describe the major components.
- Explain the theory of operation.

## Duct Burners and Selective Catalytic Reduction Systems

Module #COM0303

### Description

HRSR duct burners provide a means of increasing steam production within the HRSR through the introduction of additional thermal energy, while selective catalytic reduction (SCR) involves the injection of ammonia into the flue gas upstream of a catalyst structure. This module provides an overview of duct burners and SCRs, along with their theory of operation and description of major components.

### Learning Objectives

- State the purpose of duct burners and selective catalytic reduction systems.
- Describe the major components of duct burners.
- Explain the theory of operation for duct burners.
- Describe the major components of selective catalytic reduction systems.
- Explain the theory of operation for selective catalytic reduction systems.



## Boiler Water Chemistry

Module #COM0304

### Description

Correct chemical control and blowdown ensures efficient operation of the HRSR unit and can prevent costly repairs caused by deposits or corrosion of the HRSR tubes.

This module introduces the purpose of water chemistry, describes the parameters that are monitored, and explains the various ways to control each of these parameters.

### Learning Objectives

- State the purpose of boiler water chemistry.
- Define common terminology.
- Describe each monitored parameter.
- Describe the negative effects of operating outside recommended parameters.

## Balance of Plant



The *Balance of Plant* subject area spans various topics and systems that are not readily categorized under a main topic, but are vital to the operation of the plant. This subject area includes high-pressure steam systems, reheat and intermediate-pressure steam systems, low-pressure steam systems, auxiliary steam systems, condensers, steam plant water systems, cooling water systems, dematerialized water systems, reverse osmosis systems, compressed gas systems, wastewater systems, and compressed air systems.



### Balance of Plant Basics

#### Module #COM0401

##### Description

*Balance of plant* is a grouping of equipment, such as the condenser and the condensate system. The term comes from balancing the amount of feed flow for the HRSG to the amount of steam flow from the HRSG to maintain a constant water level in the HP, IP, and LP drums. This module provides an overview of balance of plant basics and describes common terminology applicable to the balance of plant.

##### Learning Objectives

- Define common terminology.
- State the purpose of each balance of plant system.
- Describe system interrelationships.

### High-Pressure Steam Systems

#### Module #COM0402

##### Description

The high-pressure steam system delivers high-pressure steam generated from the HRSG high-pressure steam drum to the steam turbine. This module provides an overview of the common terminology associated with this system, as well as its theory of operation and the purpose of the system's major components.

##### Learning Objectives

- State the purpose of high-pressure steam systems.
- Define common terminology.
- Describe the major components.
- Explain the theory of operation.

## Reheat and Intermediate-Pressure Steam Systems

Module #COM0403

### Description

This module provides an overview of the intermediate-pressure steam system, including its purpose and the common terminology that applies to the system. Additionally, the module explains the theory of the intermediate-pressure steam system's operation, as well as the purpose of the major components found within the system.

This module provides an overview of the cold reheat steam system, including its purpose and the common terminology that applies to the system. In addition, the module explains the theory of the cold reheat steam system's operation, as well as the purpose of the major components found within the system.

This module introduces the hot reheat steam system, describes its purpose, and defines the common terminology that applies to the system. In addition, the module explains the theory of the operation, as well as the purpose of the major components found within the hot reheat steam system.

### Learning Objectives

- State the purpose of reheat and intermediate-pressure steam systems.
- Define common terminology.
- Describe the major components.
- Explain the theory of operation.

## Low-Pressure Steam Systems

Module #COM0404

### Description

The low-pressure steam systems at a combined cycle power plant perform many important functions. This module provides an overview of the common terminology associated with these systems, as well as its theory of operation and the purpose of the system's major components.

### Learning Objectives

- State the purpose of low-pressure steam systems.
- Define common terminology.
- Describe the major components.
- Explain the theory of operation.

## Auxiliary Steam Systems

Module #COM0405

### Description

This module provides an overview of the auxiliary steam system, including its purpose and the common terminology that applies to the system. Additionally, the module explains the theory of the auxiliary steam system's operation, as well as the purpose of the major components found within the system.

### Learning Objectives

- State the purpose of auxiliary steam systems.
- Define common terminology.
- Describe the major components.
- Explain the theory of operation.

## Condensers

Module #COM0406

### Description

This module describes the functions condensers perform at a power plant. It also provides an overview of the common terminology associated with condensers, as well as its theory of operation and the purpose of the system's major components.

### Learning Objectives

- State the purpose of condensers.
- Define common terminology.
- Describe the major components.
- Explain the theory of operation.

## Steam Plant Water Systems

Module #COM0407

### Description

This module provides an overview of the steam plant water system and introduces its purpose, common terminology, and major components. In addition, the module explains how the condensate and feedwater systems are used in the steam cycle for efficient plant operation.

### Learning Objectives

- Identify the systems that comprise the steam plant water systems.
- State the purpose of condensate systems.
- Describe the major components of condensate systems.
- State the purpose of feedwater systems.
- Describe the major components of feedwater systems.

## Cooling Water Systems

Module #COM0408

### Description

The cooling water systems provide a continuous source of cooling water to various equipment heat exchangers. This module provides an over-view of the cooling water system, including the circulating water system and closed-loop cooling water system. The module also discusses each system and describes their major components.

### Learning Objectives

- State the purpose of cooling water systems.
- State the purpose of circulating water systems.
- Describe the major components of circulating water systems.
- State the purpose of closed-loop cooling water systems.
- Describe the major components of closed-loop cooling water systems.

## Processed Water Systems

Module #COM0409

### Description

This module provides an overview of the processed water systems found in a combined cycle plant, including the common characteristics and terminology used to describe these systems. In addition, the module explains the theory of operation for processed water systems and discusses how they interconnect.

### Learning Objectives

- State the purpose of the processed water systems.
- Define common terminology.
- Describe the major components.
- Explain the theory of operation.

## Demineralized Water Systems

Module #COM0410

### Description

This module introduces the demineralized water system and describes its purpose and related terminology. Additionally, the module explains the theory of the demineralized water system's operation, as well as the purpose of the major components found within the system.

### Learning Objectives

- State the purpose of demineralized water systems.
- Define common terminology.
- Describe the major components.
- Explain the theory of operation.

## Reverse Osmosis Water Systems

Module #COM0411

### Description

This module provides an overview of reverse osmosis water systems, including their basic characteristics, theory of operation, and major components. Additionally, the module describes the function and major components of reverse osmosis water systems.

### Learning Objectives

- State the purpose of the reverse osmosis water systems.
- Define common terminology.
- Describe the major components.
- Explain the theory of operation.

## Wastewater Systems

Module #COM0412

### Description

This module provides an overview of the wastewater system, including its purpose and the common terminology that applies to the system. In addition, the module explains the theory of operation for the wastewater system and describes the purpose of the major components found within the system.

### Learning Objectives

- State the purpose of wastewater systems.
- Define common terminology.
- Describe the major components.
- Explain the theory of operation.





## Compressed Gas Systems

Module #COM0413

### Description

The compressed gas system consists of two separate systems: the nitrogen system and the hydrogen system. This module explains the purpose of these systems as well as the common terminology used when working with them.

### Learning Objectives

- Describe the major components of compressed gas systems.
- Define common terminology.
- State the purpose of nitrogen systems.
- State the purpose of hydrogen systems.
- State the purpose of carbon dioxide systems.

## Instrument/Service Air System

Module #COM0414

### Description

Instrument air is used to actuate control valves and other pneumatic devices associated with each plant system. Components that use instrument air require a clean, dried air source to ensure consistent and reliable operation. This module provides an overview of the instrument/service air system, including common terminology, theory of operation, and major components contained within the system.

### Learning Objectives

- State the purpose of the instrument/service air system.
- Define common terminology related to the instrument/service air system.
- Describe the major components of the instrument/service air system.
- Explain the theory of operation of the instrument/service air system.

## Fire Protection Systems

Module #COM0415

### Description

The fire protection system protects personnel and equipment from fire, provides an immediate source of a fire extinguishing agent (water, CO<sub>2</sub>, foam) to all areas of the power plant, and provides a means of detecting and extinguishing fires in critical areas. This module introduces the characteristics of the fire protection system and provides an overview of its major components.

### Learning Objectives

- State the purpose of the fire protection system.
- Describe the major components of the fire protection system.



## Steam Turbines

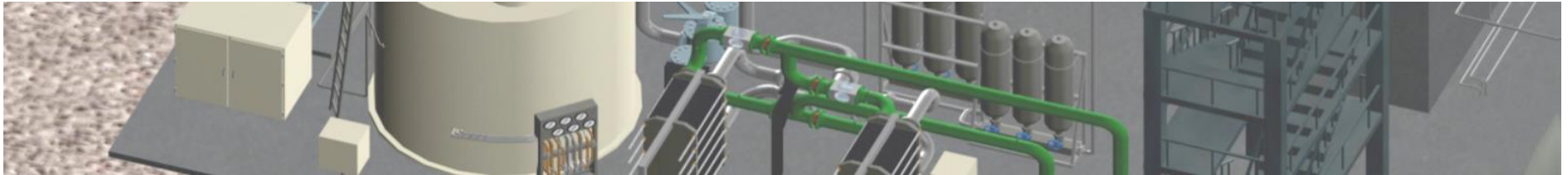

Steam turbines in a combined cycle plant receive the steam produced in the heat recovery steam generator, or HRSG, and convert the energy of the high-pressure steam to mechanical work. The rotation of the steam turbine shaft spins a generator, producing additional electrical power. The *Steam Turbines* subject area covers steam turbine basics, bearings, gland seal stream systems, lubrication, and hydraulic oil systems.

### Steam Turbine Basics

Module #COM0501

#### Description

This module introduces the various components found within the steam turbine, as well as the path in which steam flows through them. In addition, the module provides an overview of steam turbine valves, including their major components, and explains how steam turbine blading is designed.

#### Learning Objectives

- State the purpose of steam turbines.
- Define common terminology.
- Describe the major components.
- Explain the theory of operation.

### Steam Turbine Bearings

Module #COM0502

#### Description

This module provides an overview of how bearings are used within the steam turbine, as well as the common terminology that applies to bearings. In addition, this module explains the theory of operation for the different types of bearings used within the steam turbine.

#### Learning Objectives

- State the purpose of steam turbine bearings.
- Define common terminology.
- Describe the major types of bearings.
- Explain the operation of the different types of bearings.

### Steam Turbine Hydraulic Oil Systems

Module #COM0503

#### Description

This module introduces the steam turbine oil systems used within a combined cycle plant, including the lubricating oil system, hydraulic oil system, and seal oil system. The module provides an overview of the purpose of each system and describes the major components of each.

#### Learning Objectives

- State the purpose of steam turbine hydraulic oil systems.
- Define common terminology.
- Describe the major components.
- Explain the theory of operation.

## Steam Turbine Lubricating Oil Systems

Module #COM0504

### Description

This module introduces the lubricating oil system for the steam turbine, including common terminology related to the system. Additionally, the module identifies and explains the major components that make up the lubricating oil system.

### Learning Objectives

- State the purpose of steam turbine lubricating oil systems.
- Define common terminology.
- Describe the major components.
- Explain the theory of operation.

## Gland Seal Steam Systems

Module #COM0505

### Description

This module provides an overview of the steam turbine support systems, including common terminology related to the system. In addition, the module introduces the gland/seal steam system and turning gear.

### Learning Objectives

- Explain the theory of operation.
- Describe the major components.
- State the purpose of gland seal steam systems.
- Define common terminology.

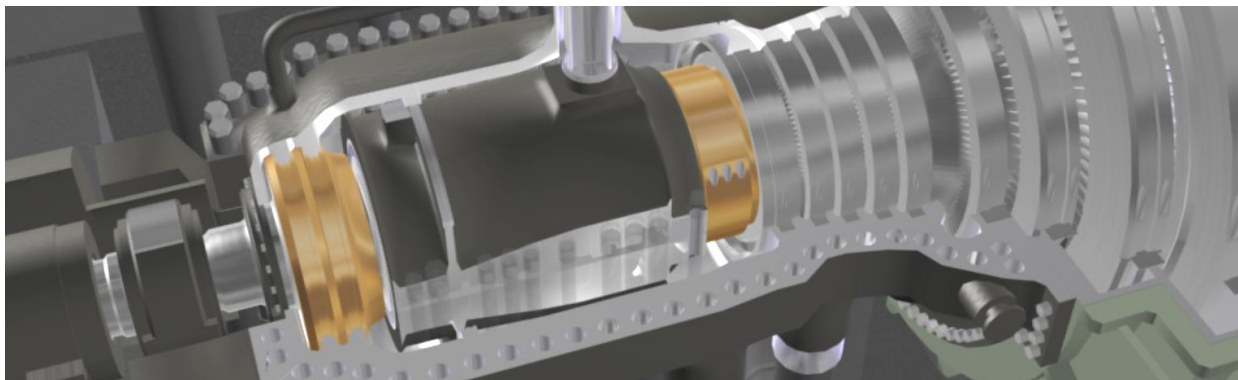

## Electrical Power Generation and Distribution



The *Electrical Power Generation and Distribution* subject area covers the fundamentals of how electrical power is harnessed and transferred throughout a plant. The subject area includes modules covering generator basics, generator cooling systems, seal oil systems, and switchyards and power distribution lines.

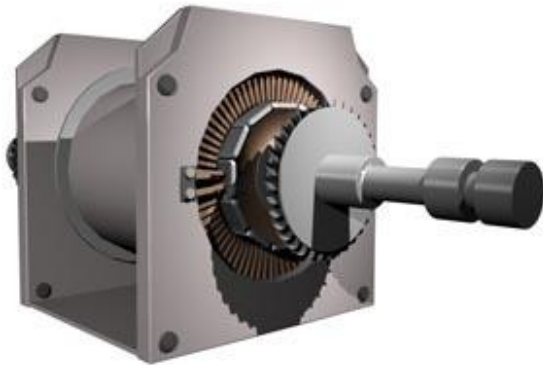

### Generator Basics

Module #COM0601

#### Description

This module provides an overview of how generators are used in a combined cycle plant. The module introduces the purpose of generators, common terminology, theory of operation, and major generator components. In addition, the module introduces the different types of generator cooling systems.

#### Learning Objectives

- State the purpose of a generator.
- Define common terminology.
- Describe the major components.
- Explain the theory of operation.
- State the conditions that cause a direct trip of the generator.

### Generator Cooling Systems

Module #COM0602

#### Description

Every combined cycle plant has at least one generator. As the generator spins during normal operation, heat builds up in its windings and rotor. This heat needs to be removed to prevent damage to the generator. The purpose of a generator cooling system is to remove this heat from the generator during normal operation. This module introduces the fundamentals of generator cooling systems.

#### Learning Objectives

- State the purpose of generator cooling systems.
- Define common terminology.
- Explain the theory of operation for air cooling systems.
- Explain the theory of operation for hydrogen cooling systems.

## Seal Oil Systems

Module #COM0603

### Description

The purpose of the seal oil system in a combined cycle plant is to prevent hydrogen from escaping the generator in an uncontrolled manner and to collect the hydrogen that does escape with the seal oil. By keeping the hydrogen in the generator's casing, the hydrogen will continue to cool the generator's windings and rotor and do so in a safe manner. This module explains seal oil systems, common terminology, major components, and its theory of operation.

### Learning Objectives

- State the purpose of seal oil systems.
- Define common terminology.
- Describe the major components.
- Explain the theory of operation.

## Switchyards and Power Distribution

### Lines

Module #COM0604

### Description

Switchyards provide the foundation and support for the conductors, insulators, circuit breakers, disconnect switches, and other equipment. This module introduces the purpose of switchyards and power distribution lines, as well as common terminology, theory of operation, and major components. In addition, the module provides an overview of the different types of relays used for generator protection.

### Learning Objectives

- State the purpose of switchyards and power distribution lines.
- Define common terminology.
- Describe the major components.
- Explain the theory of operation.
- Describe the different types of relays used for switchyard protection.





## Power Plant Efficiency



This subject area, *Power Plant Efficiency*, covers the main driver of plant efficiency, heat rate. Discussed in detail are the basics of heat rate, how to calculate it, and the factors that effect it.

### Heat Rate Basics

Module #COM0701

#### Description

*Heat rate* is the common measure of system efficiency in a power plant. The heat rate is a measure of the combined performance of the gas turbine cycle, the steam turbine cycle, and any other associated auxiliaries. This module introduces the basic characteristics of heat rate and shows you how to calculate heat rate.

#### Learning Objectives

- Describe heat rate.
- Define common terminology.
- Describe how to use the heat rate formula.
- Explain how to calculate heat rate deviation.
- Describe how plant efficiency affects return on investment.

### Effect of Major Components on Heat Rate

Module #COM0702

#### Description

This module provides an overview of how the major components of a combined cycle plant affect the heat rate within it. The components covered in this module include: the HRSG, gas turbine, steam turbine, condenser, and other applicable plant equipment.

#### Learning Objectives

- Describe how gas turbines affect heat rate.
- Describe how heat recovery steam generators affect heat rate.
- Describe how steam turbines affect heat rate.
- Describe how condensers affect heat rate.
- Describe how miscellaneous equipment affects heat rate.



## Coal Plant Fundamentals



This course explains the basics of a coal fired power facility, including overviews of major components and overall theory of operation.

The *Coal Plant Fundamentals* series consists of 13 modules. Each module takes about 30 minutes to complete at an average pace.

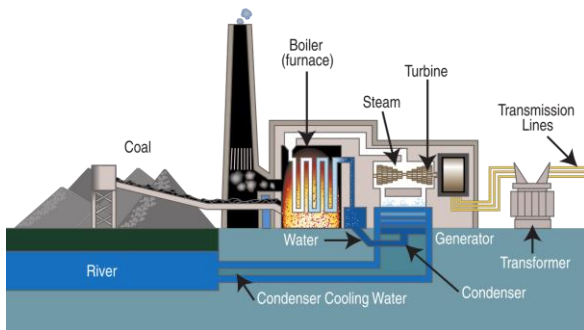

### Power Plant Overview

Course #CPF0101

#### Description

This module describes basic systems of a coal fired power plant. Take time to review each system. You will learn each system is one piece of the larger process to produce electric power.

#### Learning Objectives

- Provide an overview of a power plant.
- Name and describe the major equipment associated with a power plant.

### Boiler Fundamentals

Course #CPF0102

#### Description

This module explains how large boilers utilized in power generation depend on mechanical draft rather than natural draft air. Different types of draft are induced draft, where exhaust gases are pulled out of the boiler; forced draft, where fresh air is pushed into the boiler; and balanced draft, where both effects are employed. You will learn how to identify components of each type.

#### Learning Objectives

- Describe boiler fundamentals.
- Name and describe the major components.

## Steam-Water Cycle

Course #CPF0103

### Description

This module explains the Steam-Water (Rankine) Cycle used in conventional thermal power plants. A simple Rankine Cycle consists of only four components; the boiler (often called a *steam generator*), a turbine, a condenser, and a boiler feed pump. The steam-water process is described in detail.

### Learning Objectives

- Describe the steam-water cycle process.
- Name and describe the major components associated with the steam-water cycle.

## Boiler Water Chemistry Overview

Course #CPF0104

### Description

This module explains the process to produce boiler water with the right chemistry (quality). The Boiler Water Chemical Feed System is used to manage chemicals, tanks and pumps for chemical addition to the plant water.

### Learning Objectives

- Describe the boiler water chemistry process.
- Name and describe the major components associated with boiler water chemistry.

## Flue Gas Systems

Course #CPF0105

### Description

This module explains the chemistry of flue gas produced from the burning of fossil fuels. You will learn about what systems manage flue gas to make it safe to return to the atmosphere.

### Learning Objectives

- Describe the flue gas systems process.
- Name and describe the major components associated with the flue gas systems.

## Boiler Air Systems

Course #CPF0106

### Description

This module explains how large boilers utilized in power generation depend on mechanical draft rather than natural draft air. Different types of draft are induced draft, where exhaust gases are pulled out of the boiler; forced draft, where fresh air is pushed into the boiler; and balanced draft, where both effects are employed. You will learn how to identify components of each type.

### Learning Objectives

- Describe the boiler air systems' process.
- Name and describe the major components and processes associated with boiler air systems.

## Combustion Basics

Course #CPF0107

### Description

This module explains combustion basics. Combustion is the conversion of a substance, called a *fuel*, into chemical compounds, known as *products of combustion*, by combination with an oxidizer. The combustion process is an "exothermic" chemical reaction, which means it is a reaction that releases energy as it occurs.

### Learning Objectives

- Describe the basic combustion process.
- Name and describe the major steps associated with the basic combustion process.
- List the system parameters, set points, and alarms associated with the basic combustion process.

## Fluidized Bed Combustion Boilers

Course #CPF0108

### Description

This module explains the features of a fluidized bed combustion boiler. This type of boiler can capture more than 95% sulfur pollutants in the coal combustion byproduct which otherwise could go out to the environment. You will learn this type of boiler uses "mixing" both of gas and solids which promote rapid heat transfer and chemical reactions of the fluidized bed. The mixing action of the fluidized bed brings the flue gases into contact with a sulfur-absorbing chemical, such as limestone or dolomite.

### Learning Objectives

- Describe fluidized bed combustion boilers.
- Name and describe the major components and processes associated with the fluidized bed combustion boilers.

## Coal Handling and Preparation

Course #CPF0109

### Description

This module describes coal handling as a multi-step process that stores and prepares the coal that has been unloaded for ultimate use as fuel in the facilities' boilers. It is important to understand the handling process and interrelationship of each step.

### Learning Objectives

- Describe the coal handling and preparation process.
- Name and describe the major steps associated with the coal handling and preparation process.



## Steam Turbine Fundamentals

Course #CPF0110

### Description

This module explains the components of the steam turbine machine. The turbine is used to drive a generator or mechanical machinery. It is important to understand the specific components of the turbine, the flow of energy transferred from the boiler into the turbine and as it exists for re-use. The capacity of steam turbine can range from 50 kW to several hundred MWs for large utility power plants.

### Learning Objectives

- Describe the steam turbine fundamentals process.
- Name and describe the major components associated with steam turbine fundamentals.

## Generator Fundamentals

Course #CPF0111

### Description

This module explains generator theory. There are several components of a generator which are either mechanical or electrical. The rotating machine produces stable electrical current at a regulated voltage. The study of generator theory will help you identify components of the generator and its power island.

### Learning Objectives

- Describe the generator fundamentals process.
- Name and describe the major components associated with the generator fundamentals.

## Electrical Systems Fundamentals

Course #CPF0112

### Description

This module explains components of the electrical distribution system. The Electrical Distribution System is one of the most critical systems of the facility. Nearly every system in the plant used to support the generation of power depends on the electrical distribution system.

### Learning Objectives

- Describe electrical systems fundamentals.
- Name and describe the major components and processes associated with the electrical systems fundamentals.

## Instrumentation and Controls

### Fundamentals

Course #CPF0113

### Description

Instrumentation and control technicians maintain the safe and efficient operation of industrial measurement and control systems. A broad knowledge of multiple disciplines is required to effectively work with and troubleshoot instrumentation systems; physics, chemistry, mathematics, electronics, mechanics, and control theory all need to be applied to some extent.

### Learning Objectives

- Describe the function of basic instrument channel components.
- Identify the major similarities and differences between an instrument channel and a control channel.
- Explain the basic operation and interaction between current and pneumatic loops.

## WATER AND WASTEWATER TREATMENT

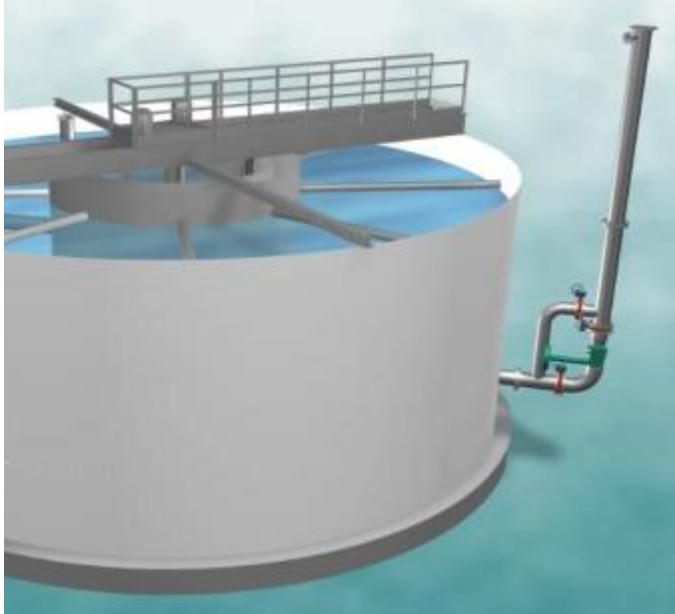

Water treatment is vital worldwide to remove contaminants from water and make it acceptable for a wide range of uses. The *Water and Wastewater Treatment* series provides general information about the processes necessary to produce water that meets the specific requirements for its usage.

The *Water Treatment* series consists of 10 modules divided into 4 sub-series.

Each module takes about 30 minutes to complete at an average pace.



## Overview of Water Treatment



The *Overview of Water Treatment* module provides learners a general description of water treatment processes and their industrial applications, as well as presents the advantages and disadvantages of water treatment.

### Overview of Water Treatment Module #WT0101

#### Description

The water treatment system is a collection of subsystems used to produce makeup water at a sufficient quality and volume for boiler and cooling system operation at a facility.

Water is brought into the system as wastewater from a local water treatment plant, filtered and treated to meet quality requirements used to support site makeup requirements, then returned to the water treatment facility.

The water first arrives into the raw water system as treated wastewater or grey water. The water is put through the clarification processes to remove suspended solids and increase clarity, and sent to the service water system.

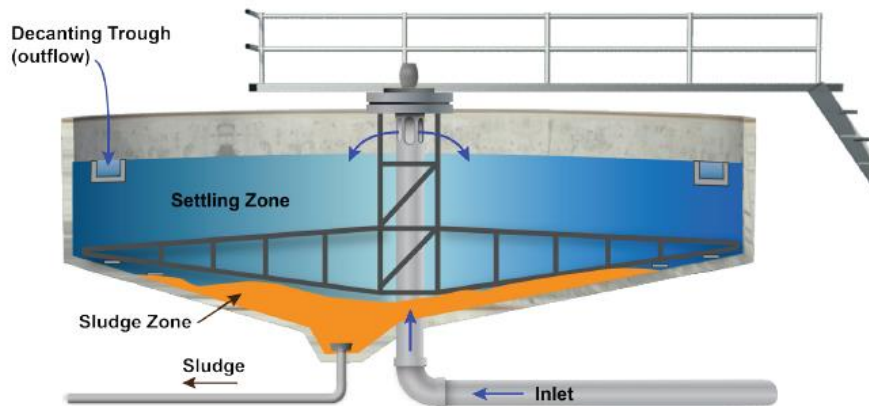

#### Learning Objectives

- Describe an overview of water treatment processes.
- Describe major industrial applications.
- Describe the major water treatment processes.
- Describe the advantages and disadvantages of water treatment.

## Raw Water Treatment



The Raw Water Treatment sub-series discusses Sedimentation, Clarification and Disinfection, processes which are an essential part of raw water treatment systems.

### Clarification

Module #WT0301

#### Description

The raw water system receives treated water, or grey water, from a water treatment plant. The incoming water is clarified to remove suspended solids and stored onsite where it is used by the service, fire, and demineralized water systems at the facility. The solids are removed, dewatered, and collected for efficient removal.

#### Learning Objectives

- Describe clarification.
- Discuss the theory of operation.
- Describe the sampling process.

### Disinfection

Module #WT0302

#### Description

One of the cleansing processes in the treatment of safe water is called *disinfection*. Disinfection is the selective destruction of pathogenic organisms, not to be confused with sterilization. Sterilization is the complete destruction of all organisms. In the U.S., the *Environmental Protection Agency* is responsible for setting drinking water standards and ensuring their enforcement. The *Safe Drinking Water Act* and its amendments contain specific maximum allowable levels of substances known to be hazardous to human health.

#### Learning Objectives

- Discuss the disinfection processes.
- Describe selection criteria.
- Discuss chlorination.
- Describe ultraviolet systems.
- Describe ozone systems.

### Sedimentation

Module #WT0303

#### Description

The purposes of the sedimentation process are to remove suspended solids, or particles, which are denser, or heavier, than water and reduce the load on the filters. The suspended solids may be in their natural state, such as bacteria, clays or silts, modified or preconditioned by prior treatment in the coagulation-flocculation process to form floc, or precipitated impurities, such as hardness and iron precipitates formed by the addition of chemicals.

#### Learning Objectives

- Describe sedimentation.
- Describe sedimentation basins.
- Discuss the theory of operation for sedimentation basins.
- Describe the factors that affect performance.
- Describe sampling and analysis of sedimentation.

## Basic Water Purification



The *Basic Water Purification* sub-series covers three processes commonly used in modern water filtration systems: Media filtration, Ultra-filtration, and Water Softening.

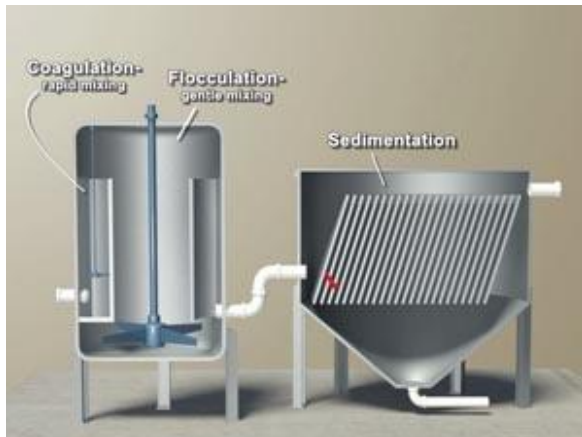

### Media Filtration

#### Module #WT0201

##### Description

Filtration is an important process in water treatment systems. It is the physical and chemical process in which impurities are removed from the water by passing it through a substance.

##### Learning Objectives

- Describe media filtration.
- Discuss water filters.
- Describe factors that affect the filtration process.
- Discuss cartridge and screen filters.
- Describe single and mixed media bed filters.
- Discuss activated charcoal filters.

### Ultra-Filtration

#### Module #WT0202

##### Description

*Ultra-filtration* refers to a type of membrane filtration in which a liquid passes through a semi-permeable membrane with a very fine pore structure to remove very small particles. The pore sizes of ultra-filtration membranes range from 0.01 to 0.001 microns. This is small enough to remove many kinds of bacteria, viruses, and high molecular weight molecules, such as proteins.

##### Learning Objectives

- Discuss membrane filtration overview.
- Describe the major components of ultra-filtration.
- Describe the theory of operation for ultra-filtration processes.
- Describe the process of ultra-filtration.

### Water Softening

#### Module #WT0203

##### Description

The presence of certain ions in water causes problems such as buildup of lime scale, fouling, galvanic corrosion, and interference with the action of soaps. Water softening is the removal of those ions. The resulting water extends plumbing and equipment lifetime and is more compatible with soap.

##### Learning Objectives

- Describe water softening.
- Discuss water softening terminology.
- Describe major water softening components.
- Discuss the theory of operation for water softening systems.
- Describe common water softening applications.



### Advanced Water Purification



The *Advanced Water Purification* sub-series covers purification methods and technologies that produce high purity water to meet the strict requirement of many industries including the pharmaceutical, food, and power generation industries.



#### Electrodeionization

Module #WAT0401

##### Description

*Electrodeionization (EDI)* removes dissolved impurities by combining two water treatment methods: Electro-Dialysis and Ion (EDI) exchange. EDI produces very high-quality water without chemical regeneration. The absence of chemicals has made it a popular method for obtaining the ultra-pure deionized water required for numerous industrial processes.

##### Learning Objectives

- Describe the process of electrodeionization.
- Describe the advantages of electronic deionizers.
- Describe major electronic deionizer components.
- Discuss the theory of operation for electronic deionizers.
- Discuss electronic deionizer maintenance.
- Describe industrial electronic deionizer applications.

#### Resin Bed Demineralizers

Module #WAT0402

##### Description

Water treatment is vital to minimizing the effects caused by impurities and foreign particles, which include fouling and corrosion that result in lower system efficiency and equipment failure. Resin bed demineralizers are commonly used in water treatment processes to remove impurities from water through the exchange of ions between the feedwater and a solid substance, called a resin.

##### Learning Objectives

- Discuss resin bed demineralizers.
- Describe an overview of demineralization.
- Discuss the types of demineralization processes.
- Describe major demineralization components.
- Discuss theory of operation for demineralization processes.
- Describe advantages and disadvantages of demineralization.

## Reverse Osmosis

Module #WT0401

### Description

Hemodialysis patients are at risk of death whenever there are contaminants in the dialysis water. Reverse osmosis, also referred to as RO, offers a way of achieving the desired water quality.

Applications world-wide include desalination and power plants as well as food and pharmaceutical industries, which require water of a specific quality. In the last decade, RO has become a popular water treatment technique; therefore, understanding RO systems is important for anyone working in industry. This module discusses the principles of reverse osmosis as well as its advantages and disadvantages.

### Learning Objectives

- State the purpose of reverse osmosis.
- Describe the principles of reverse osmosis.
- Describe the industrial applications.
- Describe the advantages and disadvantages of reverse osmosis.





## Drinking Water Treatment



The *Drinking Water Fundamentals* subject area covers methods and technologies for disinfecting, distributing, and filtering water systems and how these are used in industrial applications.

### Drinking Water Fundamentals

Module #WAT0501

#### Description

Water is essential to life. A human can only survive 5-7 days without water. However, consuming contaminated water can cause disease and death.

#### Learning Objectives

- Describe the responsibilities of the water supply facility.
- Describe the different classifications of water systems.
- Discuss three types of water.
- Explain the Hydrologic Cycle.
- List three types of groundwater aquifers.

### Drinking Water Distribution Systems

Module #WAT0502

#### Description

The primary purpose of a water distribution network is to deliver adequate volumes of safe drinking water to system customers at adequate pressures. Another important purpose of a distribution network is to provide adequate fire hydrant flows to areas of the system.

#### Learning Objectives

- Identify the key components of a distribution network.
- Describe the primary purpose of each distribution network component.
- Discuss the four types of distribution storage facilities.
- Identify some types of distribution system water quality issues.

### Drinking Water Disinfection

Module #WAT0503

#### Description

The purpose of disinfection is to remove, kill, or inactivate most microorganisms, including pathogenic bacteria, in a raw water supply. *Residual disinfection* is the process of maintaining a disinfectant level in the treated or finished water supply throughout a system to ensure that regrowth of pathogenic microorganisms will not occur.

#### Learning Objectives

- State the purpose of water disinfection.
- Describe gas chlorination for disinfection.
- Discuss the use of hypochlorite as a disinfectant.
- Explain what “ultraviolet disinfection” is and how it works.
- Explain what “ozone disinfection” is and how it works.

## Filtration I

### Module #WAT0504

#### Description

The purposes of the filtration include: compliance with treatment technique regulatory requirements; targeting impurities; and producing safe and aesthetically pleasing drinking water. The type of filtration used for water treatment depends on the initial quality of the raw water to be treated, the size of the facility, and the customer base served. In this module, the following types of filtration are discussed:

- Conventional Filtration
- Direct Filtration
- Diatomaceous Earth (or DE) Filtration

Additional types of filtration are covered in Filtration II.

#### Learning Objectives

- Identify the purposes of filtration.
- Describe conventional filtration.
- Explain direct filtration.
- Discuss diatomaceous earth filtration.

## Filtration II

### Module #WAT0505

#### Description

The purposes of the water filtration process include:

- Compliance with treatment technique regulatory requirements
- Targeting impurities
- Producing safe and aesthetically pleasing drinking water

The type of filtration used for water treatment depends on the initial quality of the raw water to be treated, the size of the facility, and the customer base served.

In this module, *Filtration II*, the following types of filtration are discussed:

- Slow Sand Filtration
- Bag and Cartridge Filtration
- Membrane Filtration

#### Learning Objectives

- Describe slow sand filtration.
- Explain bag filtration and cartridge filtration.
- Discuss membrane filtration.

## Corrosion Control Treatment

### Module #WAT0506

#### Description

Corrosion in water distribution systems can impact consumers' health, water treatment costs, and the aesthetics of finished water. Techniques for controlling corrosion include distribution and plumbing system design considerations, water quality modifications, corrosion inhibitors, cathodic protection, and coatings and linings.

This module focuses on water quality modifications through chemical treatments and corrosion inhibitors for corrosion control.

#### Learning Objectives

- Explain corrosion in water distribution systems.
- Identify corrosion control chemicals.
- Discuss chemical feed systems.

## Inorganics Removal

### Module #WAT0507

#### Description

Water containing non-degradable inorganic pollutants usually comes from both industrial and residential sewage, commercial sources, and other industries where waste is produced. Some of these biologics could break down naturally; however, processes have been developed to help nature maintain the balance needed to mitigate health concerns. Many of the techniques used to treat the non-degradable inorganic pollutants and biological methods are favored because of their efficiency and economic properties.

#### Learning Objectives

- Explain the difference between primary and secondary inorganic contaminants.
- List basic types of inorganic contaminant removal processes.
- Discuss how inorganic treatments are used.

## Organics Removal

### Module #WAT0508

#### Description

Water containing degradable organic pollutants usually comes from both industrial and residential sewage, commercial sources, and other industries where waste is produced. Many of the techniques used to treat the degradable organic pollutants, and biological methods are favored because of their efficiency and economic properties.

#### Learning Objectives

- List the four basic elements in organic chemicals.
- Identify the key methods of control and treatment.
- Explain the five components of source control.
- Identify different types of aeration equipment.
- Discuss the process of adsorption.

## Wastewater Treatment



The *Wastewater Treatment* subject area covers methods and technologies for processing and removing impurities from wastewater and how these are applied in industrial settings.

### Introduction to Wastewater Treatment

Course #WAT0601

#### Description

Wastewater treatment is the process used to convert wastewater into an effluent that can be either returned to the water cycle with minimal environmental issues or reused for residential or industrial purposes. Treatment is the act of removing impurities from water being treated. The treatment of wastewater occurs at a wastewater treatment plant.

#### Learning Objectives

- State the purpose of wastewater treatment.
- Identify the process steps in primary treatment.
- Identify the process stages in secondary treatment.
- State the purpose of advanced treatment.
- Describe the two options available in the disinfection process.
- Describe the methods of sludge stabilization.

### Disinfection and Chlorination

Course #WAT0602

#### Description

Disinfection and chlorination is an important part of the wastewater treatment. The raw wastewater is teeming with bacterial and parasitic diseases which cannot be released into the public waterways.

#### Learning Objectives

- State the purpose of disinfecting wastewater.
- List the alternative ways in which chlorine feed can be controlled.
- Describe an effective chlorine safety program.
- Identify equipment related to a gas feed system.

### Effluent Polishing

Course #WAT0603

#### Description

As more demands are placed on our water resources, the need to have cleaner water is becoming more important. Also, as more water users discharge their wastewater to the water resources, the quality of the effluent from each user needs to be cleaner to prevent any further reduction in the quality of the receiving water resources. Consequently, the discharge permits that specify the quality of the effluent discharged by the permit holder now contain more stringent conditions.

These stricter discharge requirements often require the treatment plant to provide additional facilities beyond secondary treatment known as *tertiary treatment*. This advanced treatment can be accomplished by a variety of methods such as coagulation, sedimentation, sand filtration, reverse osmosis, and extending secondary biological treatment to further stabilize oxygen-demanding substances or remove nutrients. In various combinations, these processes can achieve any degree of pollution control desired.

#### Learning Objectives

- Identify four types of filtration methods.
- Describe a typical jar test procedure.
- Discuss the four types of distribution storage facilities.
- Identify the major components of a physical chemical treatment system.

## Chemical Feed Systems

Course #WT0604

### Description

Chemical feed systems come in a variety of types including dry, liquid, gas, and polymer feed systems. They all perform the same overall function of adding chemicals to the wastewater to perform the required treatment.

### Learning Objectives

- Define *feed rate*.
- Define *flow rate*.
- Identify four types of chemical feed systems

## Laboratory Overview

Course #WAT0605

### Description

The laboratory serves a crucial function in the wastewater treatment process. It increases the efficiency in every part of the process and verifies that the process is removing the required amount of waste in the water.

### Learning Objectives

- Identify common laboratory equipment.
- Define common terms used in the laboratory.
- Describe safe work practices used in the laboratory.

## Odor Control

Course #WAT0606

### Description

Odor generation is a common problem at wastewater treatment plants. In addition to the problem odors can create for personnel and equipment, odors can adversely impact the community surrounding the treatment plant. Not only is this a problem for the community, but it also puts a strain on treatment plant resources to solve the problem and appease the community.

### Learning Objectives

- Identify the source and general types of wastewater odors.
- List three potential impacts of odors.
- Describe three methods for solving odor problems in the air.

## Rotating Biological Contractors

Course #WAT0607

### Description

Rotating Biological Contactors, or RBCs, are an example of a Fixed Film process, which is a biological treatment process where the microorganisms attach themselves to structures known as media. The biodegradable organics are removed from the wastewater as it flows past and over the media containing the attached microorganisms.

### Learning Objectives

- Describe the process of biological treatment in a Rotating Biological Contactor.
- Explain the factors affecting the performance of Rotating Biological Contactors.
- Discuss the advantages and disadvantages to using Rotating Biological Contactors.



## Activated Sludge I

Course #WAT0608

### Description

Activated sludge consists of sludge particles, teeming with living organisms and produced in either raw or settled wastewater by the growth of organisms (which include bacteria), in aeration tanks where dissolved oxygen is present.

### Learning Objectives

- Describe the activated sludge process and its control variables.
- Explain the purpose and methods of aeration.
- Describe plant safety procedures around an aeration tank.
- List six common process operational problems.

## Activated Sludge II

Course #WT0609

### Description

Modifications to the process can be made in an existing system or in the design process of a new system. Potential operational benefits of modifying the conventionally activated sludge system include:

- Increasing organic loading.
- Providing additional nutrients required for proper treatment.
- Accommodating flow rate or organic loading that varies seasonally.
- Achieving nutrient removal.

Another reason for modification of the process is to provide a treatment system that is suitable to the available site conditions. For example, extended aeration systems, especially oxidation ditch configurations, require more space than conventional systems. Alternately, where space is limited, a pure oxygen system or a complete mix configuration would be more suitable.

### Learning Objectives

- List and explain other common modifications of operating the activated sludge process.
- Explain the basic operating principles of Sequencing Batch Reactors.
- Describe the stages of operation for a Sequencing Batch Reactor.
- Describe important process control considerations for a Sequencing Batch Reactor.

## Solids Handling and Disposal

Course #WT0610

### Description

Solids from the primary clarifier (primary sludge) and secondary clarifier (secondary sludge) contain large volumes of water. This increased amount of water increases the overall volume of sludge that must be handled, increasing the size of the equipment, such as digesters, that must be installed.

To decrease this volume, the sludge can be thickened. Essentially, this results in an increase in the concentration of solids and a decrease in the total volume that must be handled in subsequent processes.

### Learning Objectives

- List and describe the various methods used for sludge thickening.
- Describe the purpose of digestion and how the anaerobic digestion process works.
- Identify the main differences between anaerobic and aerobic digestion.
- Indicate and describe the various methods for processing, dewatering and disposing of sludge.

## Treatment Ponds and Lagoons

Course #WT0611

### Description

Ponds and lagoons have been used for hundreds of years and a variety of purposes. In ancient times, organic wastes were intentionally added to ponds to stimulate the growth of algae, which acted as a food supply to increase fish populations for harvesting. Initially, the first wastewater collection systems simply discharged wastes into the nearest body of water.

The volume of wastewater increased as populations increased, and clean water bodies were negatively impacted. The need to isolate wastewater from other water sources became apparent. Therefore, treatment ponds were created to protect clean water sources by separating wastewater.

### Learning Objectives

- Describe why ponds are used in wastewater treatment.
- Identify three (3) types of ponds.
- Discuss the advantages and disadvantages of using ponds for treatment.
- Describe how the dissolved oxygen level in a pond impacts its operation.





## Trickling Filters

Course #WT0612

### Description

*Trickling Filters* are a unique type of fixed film biological treatment. In a trickling filter, the microorganisms used to treat the wastewater are attached, or fixed, to a medium as they contact the wastewater.

Wastewater applied to a trickling filter has already passed through a mechanical bar screen and/or primary clarifiers. Wastewater is distributed over the top of the medium and slowly trickles through it. The biological growth is attached to the media. This is in contrast to “suspended growth” biological treatment, where the microorganisms float freely in the wastewater.

Trickling filter effluent always passes through a clarifier to allow for capture of solids generated as a result of treating the wastewater. Although these units are referred to as *trickling filters*, no physical filtration actually occurs. Instead, contaminants are removed by biological processes.

### Learning Objectives

- Describe the process and operation of a trickling filter.
- List three abnormal operating conditions typically encountered in a trickling filter facility.
- List and describe five normal maintenance tasks required for trickling filters.
- Identify five daily operations inspections appropriate for trickling filters.

## Wastewater Collection System

Course #WT0613

### Description

The collection of wastewater is the first step in the wastewater treatment process. A variety of methods are used throughout the world to collect and transport wastewater to a treatment facility.

### Learning Objectives

- Describe three types of collection systems.
- Identify the different types of pumping stations.
- Describe the components of pumping stations.

## Sampling

Course #WT0614

### Description

To analyze a sample, it must first be collected. While this may seem obvious, the importance of collecting a representative sample cannot be overstated. If the sample is not representative, the analysis is worse than useless; it could be misleading and result in changes in treatment that are unnecessary and potentially damaging to the treatment process. The most important part of the analytical process is the collection of representative samples. Many lab errors are the result of improper sampling. The goal of sample collection is to collect a sample that is truly representative of the conditions that exist at the time of collection.

### Learning Objectives

- Identify Sample Analysis Techniques.
- Explain the importance of sampling time.
- Describe the importance of sampling.
- List common laboratory analyses performed in wastewater treatment.
- Explain why quality control is important.

## Supplemental Removal

Course #WT0615

### Description

Phosphorus and nitrogen are essential nutrients for algae growth. The discharge of phosphorus and nitrogen, along with other essential nutrients, stimulates algae growth in the streams receiving the wastewater discharge. Algae causes taste and odor problems, is aesthetically displeasing and, most importantly, creates enormous oxygen demand when algal bloom dies off. Depletion of oxygen caused by the dying algal blooms is responsible for fish kills and other significant disruptions of the aquatic environment. For these reasons, regulatory agencies often regulate the amount of phosphorus allowed in wastewater discharges.

### Learning Objectives

- Identify two distinct technology options for removing phosphorus from wastewater.
- Identify three distinct technology options for removing nitrogen from wastewater.
- Explain the purpose and process of Nitrification.
- Explain the purpose and process of Denitrification.

## MANAGER'S TOOLBOX



The *Manager's Toolbox* series consists of six core subject areas required to succeed in industry operations and maintenance from a managerial perspective: Green Sustainability, Maintenance Management, Organization-Based Maintenance Systems, Personal Effectiveness, Quality and Process Improvement, and Workforce Training.

This series consists of 36 modules, ranging from 15 to 30 minutes in length.

# Maintenance Management



The *Maintenance Management* subject area gives an overview of maintenance as well as focusing on parts maintenance, maintenance programs, and preventative maintenance.



### **Introduction to Maintenance** Module #MT0201

#### **Description**

Whether a ship at sea, a car in your driveway, or an 800 MW electrical generator at a power plant, all equipment is subjected to wear. Sometimes the wear is in the form of corrosion from exposure to chemicals or harsh atmospheric conditions. Sometimes it is due to friction or heat. Continued wear eventually results in equipment failure. Equipment is designed to perform a specific function over a defined time period. Excessive wear reduces the lifespan, causing early failures. Whatever the cause, it is the inspection, repair, and replacement of components, known as *maintenance*, that keeps the equipment running.

#### **Learning Objectives**

- State the purpose of maintenance.
- Describe three types of equipment failures.
- Identify the three primary types of maintenance.

### **Condition-Based Maintenance** Module #MT0202

#### **Description**

Condition-based Maintenance, or CBM, is the process of measuring and analyzing a parameter that has a direct relationship to the health, or operational, condition of equipment. The goal of CBM is to identify and correct equipment degradation prior to failure. CBM is also known as *condition monitoring* or *performance monitoring*, or *Predictive Maintenance*, which is abbreviated as PdM. There are a wide range of predictive technologies that support CBM.

#### **Learning Objectives**

- State the purpose of CBM.
- Explain the main types of monitoring.
- Identify the best practices to implement a CBM program.

## Parts Management and Inventory Control

Module #MT0203

### Description

Parts management and inventory control are essential parts of every industry. Decisions about parts and inventory must involve an effective management program. Without this program, major shutdowns, diminished safety, lost costs, and environmental crisis may plague your business.

### Learning Objectives

- State the reasons for managing spare parts and indirect materials.
- Describe the procurement process and associated issues.
- Identify the major areas of the warehousing and logistics processes.

## Preservation

Module #MT0204

### Description

Numerous items may be required to be kept in storage for many years. It is essential that proper methods of storage and preservation be applied so that items do not deteriorate, lose some of their properties, and/or become unusable.

### Learning Objectives

- Describe preservation.
- Identify major factors that influence deterioration of stored materials.
- Explain various methods of cleaning, preserving, and storing materials.

## Preventive Maintenance Programs

Module #MT0205

### Description

Periodic maintenance, performed to extend the life of equipment and reduce operating costs, is known as *preventive maintenance*. When you change the oil in your car, it is preventing premature failure of the engine. Your mechanic may tell you to change it every 3,000 miles. Where does this number come from?

### Learning Objectives

- State the purpose of preventive maintenance.
- Describe the basic steps for developing a preventive maintenance program.
- Describe the process to implement a PM program.

## Workflow and Controls

Module #MT0206

### Description

An important part of maintenance is a structured control program. This program provides a means to provide instructions for the maintenance technician through work orders. Work order results are recorded to provide a history of performance both of the technician and of the equipment. Performance of maintenance is scheduled for equipment access, cost control, and to maximize equipment uptime. Planning the performance of jobs allows pre-staging of parts, tools, and even pre-briefing of technicians on performance of work to increase efficiency. Tracking of performance through a series of key performance indicators will allow continuous improvement of the maintenance organization.

### Learning Objectives

- Identify the purpose and types of work orders.
- Describe the planning and scheduling process.
- Identify key performance indicators used in maintenance.

## Procedure Writing Best Practices

Module #MT0207

### Description

Procedure writing is both an art and a science. Well-written procedures reduce the number of errors and omissions in operations and maintenance, as well as assist less experienced personnel to perform complex tasks efficiently and effectively.

### Learning Objectives

- Identify the three characteristics of a valid procedure.
- Explain the basic principles that underlie effective procedure writing.
- Describe each basic principle required to write procedural steps and instructions.

# Organization-Based Maintenance



The *Organization-Based Maintenance* subject area focuses on the importance of maintenance through all areas of industry, including physical assets, employee education regarding maintenance, and workplace environments.

## Overview of Reliability Centered Maintenance

### Module #MT0301

#### Description

Reliability centered maintenance, or RCM, can be broadly defined as a maintenance planning process used to determine the maintenance requirements of physical assets in an operating environment. This module explores the features of the RCM process and key aspects of the methodology to implement it.

#### Learning Objectives

- Describe the distinct features of Reliability Centered Maintenance.
- State the steps needed to implement an RCM program.
- Identify the major steps of the RCM methodology.

## Total Productive Maintenance

### Module #MT0302

#### Description

Effective maintenance planning, particularly proactive planning, is tantamount to success in the modern workplace. Ensuring employees understand how to care for their equipment day to day and during infrequent operations and maintenance will extend its lifecycle and lessen wear. An effective maintenance planning program can minimize unplanned facility downtime and be coordinated with operations to save money during planned shutdowns.

#### Learning Objectives

- Explain the reasoning and processes behind total productive maintenance.
- Describe six pillars of the total productive maintenance strategy.
- Identify the nine major equipment efficiency and quality losses.
- Identify the five major worker efficiency losses.

## Workplace Organization – 5S

### Module #MT0303

#### Description

The workplace environment is important for every aspect of daily operations. However, being unorganized can result in significant product loss, reduced employee morale, and increased company costs. The 5S methodology exists to help establish a streamlined environment where work is processed fluidly with minimal to no interruption.

#### Learning Objectives

- Describe the 5S System.
- Explain the benefits of implementing the 5S Method.
- Identify detrimental work practices.
- Determine the impact of the 5S Method on productivity.



## Quality and Process Improvement



The *Quality Process and Improvement* subject area focuses specifically on all phases of the Six Sigma process improvement project. It also covers company strategies for success, quality management, statistical process controls and the lean manufacturing process.

### Balanced Scorecard

#### Module #MT0501

##### Description

In the 1990s, companies were looking for ways to transition from the Industrial Age to the competitive Information Age. As organizations attempted to compete, they tried a variety of methods – Total Quality Management, Lean Production, Employee Empowerment, and Reengineering – each with varying levels of success. The *Balanced Scorecard* method was derived from companies' visions and strategies for success.

##### Learning Objectives

- State the purpose of the balanced scorecard process.
- Describe the four parts of a balanced scorecard.
- Explain the steps for implementing a balanced scorecard system.

### Introduction to Six Sigma

#### Module #MT0502

##### Description

While Six Sigma has many tools that can be used in the development and improvement of both products and processes, this module focuses on the area of process improvement. Process improvements are very important for a company's ongoing success and analyzing operational data can significantly enhance operating efficiencies. The methods and tools described in this module will help you understand the basic approach to any process improvement initiative.

##### Learning Objectives

- Discuss the phases of DMAIC.
- Define the Problem.
- Measure Performance.
- Improve the Process.
- Control Performance.

### Six Sigma – Introduction to DMAIC

#### Module #MT0503

##### Description

Six Sigma is a scientific methodology used to improve customer satisfaction and reduce product variation. Six Sigma can be broken down into different areas of focus, such as process improvement, process generation, and process management. The process improvement area of Six Sigma known as *DMAIC* is discussed in this module.

##### Learning Objectives

- Discuss the phases of DMAIC.
- Define the Problem.
- Measure Performance.
- Improve the Process.
- Control Performance.



## Six Sigma – DMAIC Tools I

Module #MT0504

### Description

DMAIC is an acronym that stands for *Define, Measure, Analyze, Improve, and Control*. These are the phases of a Six Sigma process improvement project. Various analytical methods are available to a Six Sigma team for discovering problems, analyzing situations, and improving business processes.

### Learning Objectives

- Describe the tools used in the *Defining the Problem* phase.
- Describe the tools used in the *Measuring Performance* phase.
- Identify detrimental work practices.
- Describe the tools used in the *Analyze Opportunity* phase.

## Six Sigma – DMAIC Tools II

Module #MT0505

### Description

Developing and applying solutions to known root causes can be simplified through various techniques, some of which are discussed in this module. It is important to know what techniques to use for each situation if the project is to achieve optimal efficiency and success.

### Learning Objectives

- Describe the tools used in the DMAIC phases.
- Improve the process.
- Control performance.

## Introduction to Lean

Module #MT0506

### Description

Lean production, or simply “lean,” is a manufacturing process approach that considers resources wasted when used for anything but adding value to a product as seen by the customer. While many industries can benefit from the introduction of lean concepts, this presentation focuses on the maintenance operations within a business.

### Learning Objectives

- Describe lean production, including waste management techniques and the eight types of waste.
- Discuss the implementation process of the lean system, the changes involved in a process, and its benefits to a business.
- Identify the foundations for lean production, including its associated difficulties.

## Statistical Process Control

Module #MT0507

### Description

*Statistical Process Control* is a system that employs methods of statistical analysis for determining and monitoring process variability. Statistical Process Control, or SPC, was developed by Dr. Walter Shewhart in the 1920s and later further pioneered by Dr. W. Edwards Deming. SPC is used for process monitoring to determine areas of process instability. SPC also serves as an early detection system to predict future performance.

### Learning Objectives

- Explain the two types of *Variation* in a process.
- Define *Normal Distribution* as it applies to SPC.
- Discuss types of Control Charts.
- Discuss the purpose behind rational sub-groups.
- Discuss tools used in SPC.

## Total Quality Management

Module #MT0508

### Description

Total Quality Management, or TQM, is a concept focused on ensuring that quality in production and services remains a driving force in the business model. TQM was the first philosophy to focus on quality from the customer's point of view as the driving factor for an organization's definition of product quality.

### Learning Objectives

- State the purpose of Total Quality Management.
- Describe the four categories of quality costs.
- Describe the continuous improvement cycle.
- Explain the concept of rational sub-groups.
- Describe the seven concepts of the total quality management philosophy.

## Personal Effectiveness



The *Personal Effectiveness* subject area focuses on the skills necessary for optimal employee performance, including coaching, delegation, communication, group decision making, project management and finance.

### Coaching

Module #MT0401

#### Description

The textbook definition of a coach is “one who instructs or trains,” though it’s really much more than that. Coaching is an ongoing exchange between two people during which one imparts knowledge and experience to the other through a positive and supportive emotional bond. When successful, coaching is beneficial for both parties in many ways. Although, there are many different types of coaching, this module focuses on business coaching.

#### Learning Objectives

- Explain the benefits of coaching.
- Recognize when you should coach.
- Improve your coaching approach.
- Avoid common coaching mistakes.

### Delegation

Module #MT0402

#### Description

The ability to successfully delegate projects is the most important skill a leader can possess. Delegation isn’t just a matter of telling other people what to do. It is a development tool that will, when used correctly, save you time, develop and empower your team, and encourage promotion. In this module, you will learn a few basic techniques to delegate tasks more efficiently and ensure that you are giving the right jobs to the right people.

#### Learning Objectives

- Describe the necessity of delegation.
- Successfully delegate.
- Effectively manage delegation.
- Use delegation as a developmental tool.

### Effective Listening in the Workplace

Module #MT0403

#### Description

The most significant way to improve communication in the workplace is to recognize the importance of listening as the most valuable element of interpersonal communication skills, and make it an integral part of your team’s environment. Active listening goes well beyond the act of simply hearing. It is a technique that involves giving the speaker your undivided attention without interrupting, and observing their body language for non-verbal messages. This module is designed to teach you the basics of effective listening and solutions to common mistakes in the verbal communication process.

#### Learning Objectives

- Practice key behaviors for active listening.
- Recognize different communication styles.
- Avoid verbal communication mistakes.

## Effective Written Communications

Module #MT0404

### Description

Effective communication, particularly through the written word, is tantamount to success in the modern workplace. Flawless communication helps build teams who share trust and respect. It also fosters learning and develops a forum for sharing ideas and reaching a common goal. By learning a few basic writing rules – and learning to use clear, concise language – you can become a more effective communicator.

### Learning Objectives

- Follow the PASS model to construct more effective emails.
- Use the five elements of Effective Communication (TIARA) when composing an email.
- Avoid errors with Ten Tips for Better Business Writing.



## Group Decision Making

Module #MT0405

### Description

Every day, managers are faced with various decisions that concern both their employees and customers. Some decisions are simple, such as assigning tasks, while others are more difficult, such as finding a new supplier or cutting expenses. Understanding that decision making can be a process instead of a single event allows managers to attack problems of varying complexity with an arsenal of analytical tools and diverse perspectives.

### Learning Objectives

- Identify and describe phases involved in the decision-making process.
- Define the guidelines for effective communication.
- Identify commonly encountered obstacles.
- Prove final decisions meet initial expectations.

## Basic Business Finance

Module #MT0406

### Description

In the business world, there are many different areas that must be considered in the management of daily activities and long-term planning. These areas include facilities and equipment, safety, regulations, product shipping, information handling, supplier and employee issues, and the financial needs of the company. Since the accounting and financial side of the business is so important to the handling of other issues, we need to understand how it functions.

### Learning Objectives

- Identify the most common asset, liability, and equity accounts.
- Identify the four major financial statements.
- Describe auditing, both internal and external, and the components of financial reporting.

## Project Management Fundamentals

Module #MT0407

### Description

*Project management* is the application of processes, skills, tools, and techniques to achieve a desired result. For some, the term “project management” conjures up an image of rigid forms and software systems that waste time and slow down a project. Actually, the opposite is true - projects fail because of a lack of project management.

### Learning Objectives

- Describe the characteristics of a project.
- Explain the project initiation process.
- Summarize the project planning process.
- Describe the project executing process.
- Discuss the monitor and control phase.
- Explain the project closure phase.



# Workforce Training



The *Workforce Training* subject area focuses on creating an effective workplace through training. It covers various training methods as well as the ADDIE model.

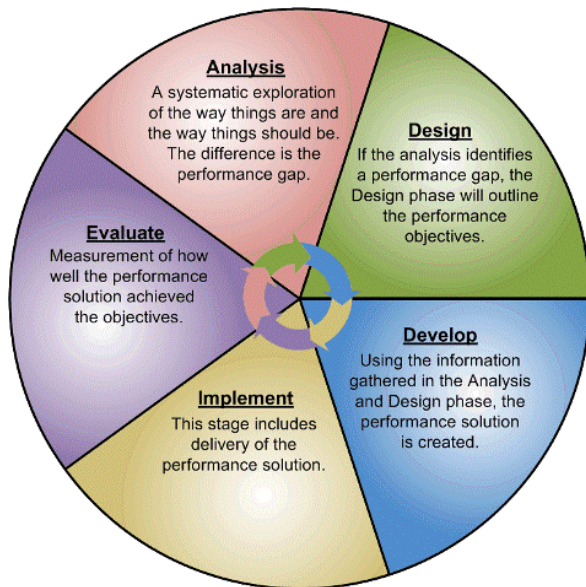

## ISD Overview

### Module #MT0601

#### Description

Instructional Systems Design (ISD) is the methodology used to create a learning experience that makes the acquisition of knowledge and skill efficient, effective, and engaging. Instructional design is historically and traditionally rooted in cognitive and behavioral psychology; although, learning theory has now emerged as a distinct field. The ISD process requires:

- Determination of the current state and needs of the learner (needs assessment)
- Definition of the end goal of instruction (objectives)
- Creation of a learning "intervention" to achieve the objectives (learning content)

Ideally, the process is based on sound methodologies. Additionally, the outcome of the training intervention may be directly observable and measured.

#### Learning Objectives

- Describe the types of ISD models, with an emphasis on ADDIE.
- Classify Bloom's taxonomy for the cognitive domain.
- Explain ARCS motivational model and how it applies to ISD theory.

## Training Analysis

### Module #MT0602

#### Description

Analysis provides a method of responding to changes in human resource requirements, solving job performance problems, and learning from production experience. Analysis begins by gathering the facts needed to make informed training development decisions. It is necessary to gather facts and ensure that concerns can be resolved through training. If the facts confirm a valid training need, job analysis uses existing job data and employees to identify and rate job tasks. Tasks rated difficult and important are selected for training. Exact methods of correct performance and underlying competencies are then determined through task analysis for the tasks selected for training.

#### Learning Objectives

- State the purpose of a training analysis.
- Describe the components of a typical analysis report.
- Describe how to conduct an analysis.



## Design of Effective Workplace

### Learning

Module #MT0603

#### Description

The *Design* phase of the ADDIE model uses the task performance information collected during the *Analysis* phase to specify, in measurable terms, the knowledge, skills, and abilities that training will develop in the employee. Job performance measures are prepared for each task. Defining how individual tasks are performed focuses training development efforts and supports in-plant training and qualification.

Performance objectives are developed for groups of task-related knowledge and skills. The performance objectives define what action the employee must perform, under what conditions, and to what standard. Tests are produced to ensure that the objectives are evaluated in a reliable manner. *Design* ends with development of a training plan. The work product from the *Design* phase is the Content Design Document, or CDD, that is used as the basis for content development.

#### Learning Objectives

- Describe how to write performance-based enabling objectives.
- Explain how to design a learning strategy based on the learning objectives.
- Describe the primary factors to consider when selecting a learning strategy.

## Practical Training Development

### Methods

Module #MT0604

#### Description

Now that we've covered the *Analysis* and *Design* phases, the *Development* phase of the ADDIE model can begin. As discussed previously, *Development* commences based upon the selected delivery strategy outlined in the Content Design Document, or CDD. There are certain commonalities of all development efforts; specifically, each learning object will be based upon the following:

- Create a Prototype
- Develop the Module Materials
- Standardized Review and Revision Process
- Testing/Piloting Process

The amount of time spent on each step will be dictated by the project type and client expectations. For some projects, an extensive prototype development must take place first before the client signs off on moving forward with the entire project. Other projects will require a more intensive pilot session or development of the actual module materials.

#### Learning Objectives

- Describe how to create a prototype for a training project.
- Explain the development process of module materials.
- Recognize best practices for administering a pilot session.

## Implementation of Workplace

### Learning

Module #MT0605

#### Description

*Implementation* is the process of putting training programs into operation. It begins by activating the training plan, specific to the learning strategy. For example, for instructor-led programs, instructors are selected and trained, and the availability of employees, facilities, and resources is confirmed. Facilities are evaluated and prepared for instruction, and the material fulfillment process is initiated to ensure participant materials are printed, bound, and shipped in a timely manner.

Implementation of eLearning programs are more focused on selected platform deployment and assignment of the learning to the target audience.

Learner assignment, management, and tracking are accomplished through the platform. However, in some cases, the platform for a specific client has not been selected or needs to be evaluated for suitability for the type of online content to be deployed.

#### Learning Objectives

- Describe the Implementation phase of the ADDIE model.
- Identify best practices and common challenges for launching blended learning programs.
- Describe the benefits of implementing a blended learning program.

## Training Evaluation

Module #MT0606

### Description

The ADDIE *Evaluation* phase helps companies measure a module's impact on their learners. In industry, evaluation ensures training's ability to continually produce qualified employees. Monitoring learner performance, equipment and procedure changes, and production experience helps maintain and improve the training program. Evaluation is the dynamic process of assessing performance, identifying concerns, and initiating corrective actions that ensures the achievement of the program goals.

Completing evaluation steps produces the performance data and feedback that is vital to any training system. In most cases, evaluation does not add much additional cost to the training project. Training evaluation should take place immediately after module implementation, and additionally, a few months later.

### Learning Objectives

- Distinguish between the different types of evaluation assessment tools.
- Describe the guidelines for creating the different types of evaluation assessment tools.
- Describe the key components used to design a job performance measure.

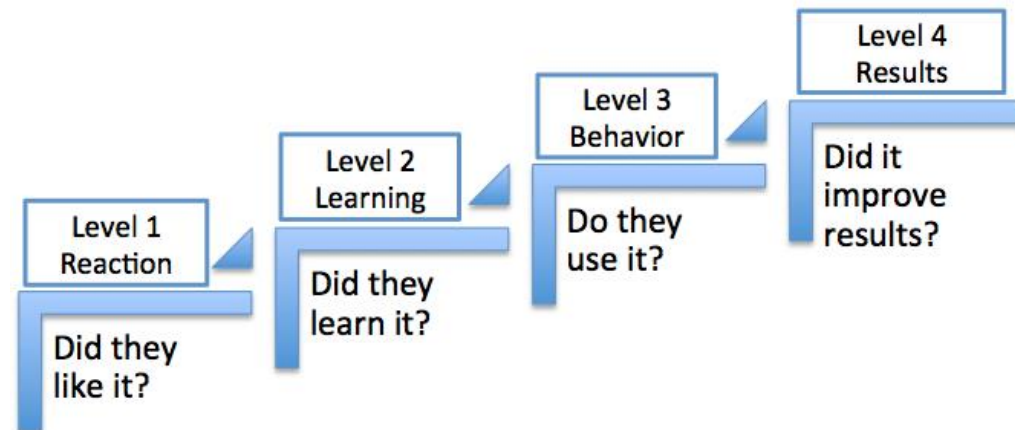

## Green Sustainability



The *Green Sustainability* subject area focuses on the information necessary for green building as well as the environmental and cost benefits.

### Concepts in Green Purchasing

Module #MT0101

#### Description

This module defines green purchasing and discusses how to achieve green purchasing. It also covers how to explain the EPA's DfE program.

#### Learning Objectives

- Define green purchasing.
- Describe how green purchasing is achieved.
- Explain the EPA's DfE program.

### Energy Ratings and Audits Defined

Module #MT0102

#### Description

This module teaches the importance of energy audits and certification of buildings. It also covers how global climate issues affect insurance, and describes common energy standard organizations.

#### Learning Objectives

- Explain why energy efficiency audits and certification of buildings is important.
- Explain how global climate issues affect insurance.
- Describe common energy standard organizations.

### Energy-Efficient Systems

Module #MT0103

#### Description

This module covers some of the advantages of energy-efficient systems. It also reviews examples of how some energy-efficient systems can save resources.

#### Learning Objectives

- Discuss the advantages of energy-efficient systems.
- Describe examples of energy-efficient systems.

## Green Building Adding to the Bottom Line

Module #MT0104

### Description

This module identifies economic facts about green building. It also discusses the economic benefits of “green” building.

### Learning Objectives

- Identify economic facts about green building.
- Describe the economic benefits of green buildings that meet LEED® Gold certification.

## Green Building and Renovations Defined

Module #MT0105

### Description

This module covers how to define “green” building and renovations.

### Learning Objectives

- Define “green” building and renovations.

## Green Certification and Standards

Module #MT0106

### Description

This module describes LEED green certification categories. It also identifies common green building standards.

### Learning Objectives

- Identify LEED® green building certification levels.
- Describe Green Building Standards



## BUILDING MANAGEMENT AND MAINTENANCE



All facilities will require a certain amount of upkeep, and will definitely require repairs. Learn more about facility upkeep here in the *Building Management and Maintenance* series of modules.

This series consists of 29 modules. Each module takes about 30 minutes to complete at an average pace.



## Building Management Principles



*Building Management Principles* modules include Risk Management, Preventive Maintenance, Practice and Procedures, and Cleaning Services. This subject area describes what risks are inherent in a facility and the ways to mitigate them to maintain an efficient operation.



### **Risk Management** Module #BMM0101

#### **Description**

This module covers general liability as it relates to facility risk management, explains what attractive nuisances are, and describes risk management. This module also explains the differences in active and passive fire protection systems while discussing management's responsibility to minimize fire risks, provides an overview of the *Life Safety Code*, and lays out the components of an egress system.

#### **Learning Objectives**

- Define the term "general liability" as it applies to facility risk management.
- Discuss examples of attractive nuisances.
- Identify methods of mitigating the risk of trips and falls by non-employees.
- Define "risk management."
- Differentiate between active and passive fire protection systems.
- Discuss the responsibilities management has in mitigating fire risks.
- Explain the concept of the *Life Safety Code*.
- Identify components of an egress system.

### **Preventive Maintenance** Module #BMM0102

#### **Description**

This module introduces preventive maintenance and its advantages. This module also covers preventive maintenance programs and computerized maintenance management systems.

#### **Learning Objectives**

- Identify the attributes of a successful preventive maintenance routine.
- Describe the best practices to be used when creating a preventive maintenance schedule.
- Identify the key indicators that should be monitored for a preventive maintenance plan to be successful.

## Cleaning Services

Module #BMM0103

### Description

This module covers common supplies and processes to cleaning facilities.

### Learning Objectives

- Describe common cleaning supply storage and management.
- Describe methods for cleaning facility common areas.
- Describe general procedures for cleaning an elevator.
- Describe general procedures for cleaning pools and pool decks.



## Chemical Storage

Module #BMM0104

### Description

This module gives an overview on the procedures of storing chemicals and storage time limits that will minimize accidents and increases life of the chemicals.

### Learning Objectives

- Identify the requirements for separating chemicals.
- Describe the basic guidelines for safe storage of chemicals.
- Identify various storage time limits of peroxide-forming compounds.

## Facility Management

Module #BMM0105

### Description

This module covers the purpose of building codes, the identification of sections of a facility that have specific code requirements, and defines the role of a facility manager as it relates to facility security. Also identified are types of physical security measures used to prevent unauthorized access to a facility and discuss plans related to preparing for a natural or man-made disaster.

### Learning Objectives

- State the purpose of building codes.
- Identify sections of a facility that have specific code requirements.
- Identify sections of a facility that have specific code requirements.
- Identify types of physical security measures used to prevent unauthorized access to a facility.
- Discuss plans related to preparing for a natural or man-made disaster.

## Building Utilities and Boilers



The *Building Utilities and Boilers* subject area includes information about the utilities used at an industrial facility, with emphasis on boilers and combustion. Topics about boilers include combustion fundamentals, types and classification, operation, safety equipment, controls and management control systems.

### Combustion Fundamentals

#### Module #BMM0201

##### Description

This module covers the fire triangle, basic combustion process, operation for certain burners, and the purpose of burner turndown.

##### Learning Objectives

- Name the three basic elements required for combustion to occur.
- Briefly describe the combustion process.
- Briefly describe the operation of the following types of burners: oil, pressure jet, rotary cup, gas, and dual fuel.
- State the function of burner turndown.

### Boiler Types and Classifications

#### Module #BMM0202

##### Description

This module covers multiple kinds of boiler systems and what differentiates them from each other.

##### Learning Objectives

- Describe a hydronic (hot water) boiler system.
- Describe a steam and condensate boiler system.
- Differentiate between a fire-tube and a water-tube boiler.

### Boiler Operations

#### Module #BMM0203

##### Description

This module covers boiler system operations including: startup and shutdown of the system and steam and hot water control settings.

##### Learning Objectives

- Explain routine operation of a boiler system.
- Describe a typical boiler shutdown procedure.
- Describe a normal startup sequence of a boiler system.
- Identify steam and hot water control settings necessary for boiler operation.

### Boiler Systems

#### Module #BMM0204

##### Description

This module outlines boiler system terminology and components. This module also covers the purposes of boiler room valves and the types of data that can be found on the valve.

##### Learning Objectives

- Identify common HVAC and boiler symbols and terminology.
- Explain the function of the main boiler system components.
- Explain the functions of boiler room valves.
- Describe the types of data found on valve identification and markings.

## Boiler Blowdown

Module #BMM0205

### Description

This module covers the purposes, operation, and different types of boiler blowdown systems.

### Learning Objectives

- State the purpose of boiler blowdown.
- Describe the processes of continuous and manual blowdown.
- Describe a proper blowdown procedure.
- Explain why water quality is important to boiler systems.

## Boiler System Controls

Module #BMM0206

### Description

This module introduces typical boiler system controls which provide safe operation of a boiler.

### Learning Objectives

- State the functions of common steam, hot water, gas, oil, and heavy oil controls.

## Boiler Management Control Systems

Module #BMM0207

### Description

This module covers flame safeguard systems and different types of flame detectors, along with describing the typical sequence of operation.

This module also explains how the control system will react when it experiences certain flame loss conditions along with the importance of keeping a history/troubleshooting log for the equipment.

### Learning Objectives

- Explain the function of the flame safeguard system.
- Describe a typical boiler management control sequence of operation.
- Identify switches and controls commonly used within interlocks and circuits of a boiler.
- Describe how the control system responds to the following flame loss conditions: no pilot flame, pilot lit with no main flame, and loss of flame.
- Describe a typical burner shutdown and post-purge process.
- Explain the importance of an equipment history/troubleshooting log.

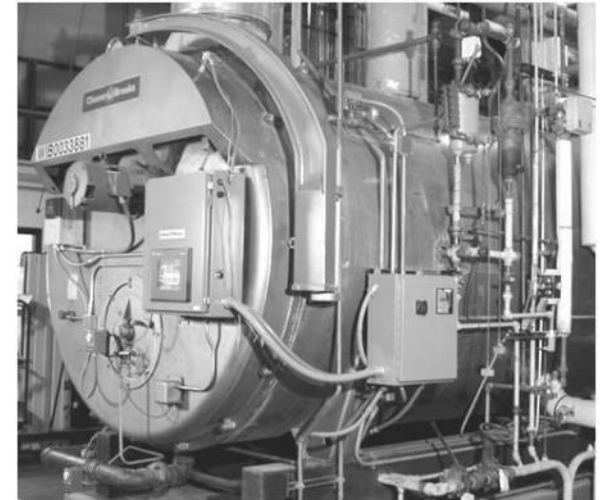

## General Inspections and Repairs



This subject area, *General Inspections and Repairs*, describes various elements that must be subjected to regular inspections and repairs around a facility.

Modules in this subject area include Cleaning Drains, Faucet Repair, Pipe Repair and Replacement, Basic Masonry, Drywall, Doors, and Locks, HVAC Fundamentals, Elevators, Overhead Door Controls, and Roofing, Walls, and Balconies.

### Cleaning Drains

Module #BMM0301

#### Description

This module covers the various methods for cleaning different kinds of clogged drains.

#### Learning Objectives

- Describe how to clear clogged floor, sink, and lavatory drains.

### Faucet Repairs

Module #BMM0302

#### Description

This module covers repairing ball-type, single-lever, cartridge-type, and different types of noisy/leaking faucets.

#### Learning Objectives

- Describe how to repair ball-type, single-lever and cartridge-type faucets.
- Describe how to repair various types of noisy/leaking faucets.

### Pipe Repairs and Replacement

Module #BMM0303

#### Description

This module covers boiler system operations including: startup and shutdown of the system and steam and hot water control settings.

#### Learning Objectives

- Make repairs to leaking piping systems.
- Make repairs to leaking toilets and urinals.





# Building Management and Maintenance Series

---

## Basic Masonry

Module #BMM0304

### Description

In this module, you will learn the basics of Masonry tools and the methods of repairing for which these tools are used.

### Learning Objectives

- Identify the common tools used for performing basic masonry maintenance tasks.
- Describe the process of performing basic masonry repairs on concrete including hairline cracks, large sidewalk cracks, cracks in driveways, cracks, and holes in walls, and broken corners.

## Drywalls, Doors, and Locks

Module #BMM0305

### Description

This module covers basic carpentry, drywall and door repairs, and the correct process for extracting a broken key from a lock.

### Learning Objectives

- Perform basic carpentry jobs such as:
  - Determining the cause of and repairing sticking or binding doors.
  - Repairing holes in drywall.
  - Preparing for painting.
- Explain the proper method of removing a broken key from a lock.

## HVAC Fundamentals

Module #BMM0306

### Description

This module gives an overview of the purpose of HVAC systems, the equipment and methods used to heat, cool, and handle the systems, and the different types of HVAC systems.

### Learning Objectives

- State the purpose of heating, ventilation, and air conditioning systems.
- Identify the equipment and methods used to heat, cool, and handle HVAC system air.
- Describe the different types of HVAC systems.

## Basic HVAC Maintenance

Module #BMM0307

### Description

In this module, you will learn the basics of HVAC systems, their operation, and maintenance. This module also covers problems and solutions for window-mounted units along with preventive maintenance.

### Learning Objectives

- Identify routine preventive maintenance tasks to be performed on HVAC units.
- Describe common problems and their causes for HVAC units.
- Explain the basic refrigeration cycle.
- Identify routine preventive maintenance tasks to be performed on window-mounted units.
- Describe solutions to problems common to window-mounted units.



## Elevators I

### Module #BMM0308

#### Description

This module introduces the different types of elevators, servicing these elevators, the ownership responsibilities, and the fireman's recall system.

#### Learning Objectives

- Identify the major components of a traction elevator and of a hydraulic elevator.
- Describe the principles of operation for a traction elevator and a hydraulic elevator.
- Identify monthly service requirements of elevators.
- Discuss the responsibilities of ownership in ensuring elevator service requirements are up-to-date.
- Describe the actions taken in each of the two phases of emergency elevator operation using the fireman's recall system.

## Elevators II

### Module #BMM0309

#### Description

This module gives an overview of the required elevator tests and codes along with the accessibility standards that must be met.

#### Learning Objectives

- Identify the standards for elevator system inspection commonly required by governing authorities.
- Discuss accessibility standards that must be adhered to in order to remain in compliance with the *Americans with Disabilities (ADA) Act*.



## Overhead Door Controls

### Module #BMM0310

#### Description

This module covers overhead door controls, the manual operation of the overhead doors, identifying which components require routine lubrication, and adjusting a door control limit switch.

#### Learning Objectives

- Identify common components for commercial overhead doors.
- Explain the manual operation of overhead doors.
- Identify mechanical components in an overhead door system requiring routine lubrication.
- Describe how to adjust a door control limit switch.

## Roofing, Walls and Balconies

### Module #BMM0311

#### Description

This module covers important inspection techniques of roofing, walls, and balconies. This includes balcony inspections, roofing materials and their usage, and various rooftop tanks.

#### Learning Objectives

- Describe how a fire suppression system operates.
- Describe balcony inspection requirements.
- Define common roofing terms.
- Define common roofing terms.
- Describe steep-slope roofing systems.
- Describe common water tank construction and uses.
- Describe common water tank construction and uses.

### Building Electrical Maintenance



Ensuring that the electrical system in an industrial facility, or any facility for that matter, is functional and safe for personnel is paramount.

The *Building Electrical Maintenance* subject area covers topics including electrical control circuits, tools and test equipment, distribution components, receptacles, and lighting.



#### Overview of Electrical Systems Module #BMM0401

##### Description

This module provides an overview of electrical systems and identifies the various facility power distribution systems and equipment, the safety of electrical equipment, the work space around electric equipment, the identification of disconnecting means and circuits, and guarding live parts. This module also covers how the power grid works and discusses power generation and power transmission.

##### Learning Objectives

- State several considerations for determining the safety of electrical equipment.
- Explain the reason for identifying disconnection means of electrical equipment.
- Explain the reason for maintaining proper working space around electrical equipment.
- Explain the reason for guarding live parts of electrical equipment.
- Briefly describe how the power distribution grid works.

#### Electrical Control Circuits Module #BMM0402

##### Description

This module covers control circuit diagrams and how to differentiate between the different types. This module also explains control circuit logic and the related terms.

##### Learning Objectives

- Differentiate between a wiring, or connection, diagram and a line, or ladder, diagram.
- Describe the following conditions of device contacts: normally open, normally closed.
- Define logic as it is used in control circuits.
- Explain the function of two basic types of control circuit logic functions: AND and OR.
- Define interlocking as it applies to electrical control circuits.
- Describe the following types of commonly used interlocking techniques: mechanical, pushbutton, auxiliary, and control relay contact.

## Electrical Tools and Test Equipment

Module #BMM0403

### Description

This module covers common electrician's tools and the standard types of meters used for measuring current, voltage, and resistance.

### Learning Objectives

- State the uses of common electrician's tools.
- State the functions of common types of electrical test equipment.



## Electrical Distribution Components

Module #BMM0404

### Description

Building maintenance requires a basic understanding of the components responsible for the distribution of electricity throughout a building or facility. This module discusses different types and sizes of conductors, raceways and conduit, as well as the differences between a circuit breaker panel, switchgear, and motor control center.

### Learning Objectives

- Define the following common electrical terms: voltage, current, resistance, and power.
- Define square mil, circular mil, and circular mil-foot.
- Explain the reason for proper identification of conductors.
- Define raceway.
- State two purposes of conduit.
- Describe electrical metallic tubing and flexible metal types of conduit.
- Describe the functions of circuit breaker panels and load centers in power distribution systems.

## Receptacles and Lighting

Module #BMM0405

### Description

This module introduces common electrical terms, the methods of determining types of conductors, and conduits and raceways.

### Learning Objectives

- State several considerations for determining the safety of electrical equipment.
- State several considerations for determining the safety of electrical equipment.
- Explain the reason for maintaining proper working space around electrical equipment.
- Explain the reason for guarding live parts of electrical equipment.
- Briefly describe how the power distribution grid works.





## DISTRIBUTION AND WAREHOUSING

The *Distribution and Warehousing* series starts with the basics of operations including maintenance, the overall work order process, fork trucks, and conveyors.

The intermediate level focuses on more of the day to day equipment used including battery charging systems, photo-eyes, sorter fundamentals, and switchgear.

The final level gets into the more advanced systems found in distribution facilities including automatic guided vehicles (AGVs), cranes, and scanners.

This series consists of 20 modules. Each module takes about 30 minutes to complete at an average pace.



# Basic Distribution and Warehousing



*Basic Distribution and Warehousing* modules include Risk Management, Preventive Maintenance, Practice and Procedures, and Cleaning Services. This subject area describes what risks are inherent in a facility and the ways to mitigate them to maintain an efficient operation.

### Distribution Center Overview

#### Module #MDW0101

##### Description

This module covers the process in which a product makes its way from the vendor to the market and the basics of distribution. This module also covers the layout of the distribution centers as well as the modules associated with those centers.

##### Learning Objectives

- Describe the basic flow of product from a manufacturer to a customer.
- Describe the major functional areas of a distribution center.
- Describe the product flow within the distribution center.

### Conveyor Basics

#### Module #MDW0102

##### Description

This course covers different types of conveyors, such as gravity-driven, flat belt, and live roller conveyors, that are used in distribution centers. This course also covers specialty devices such as skewed wheel belt sorters and shoe-type sorters, as well as live roller and high-speed junctions and curves.

##### Learning Objectives

- Describe the different types of conveyors used in distribution centers.
- Identify the key differences between the various conveyor types.
- Explain the different conveyors and their uses.
- Describe other specialty devices used by conveyors.

### Facility Maintenance

#### Module #MDW0103

This course provides an overview on general facility maintenance, electrical safety, and the maintenance of lighting systems. This course also teaches the compressed air components and their components associated with facility maintenance and the various plumbing systems. Lastly, this course discusses the chilled water systems maintenance and components and the fire main system maintenance and components.

##### Learning Objectives

- Recognize basic facility systems.
- Describe basic lighting maintenance.
- Identify basic compressed air system components.
- Explain basic plumbing system maintenance.
- Identify basic chilled water system components.
- Describe basic fire main system maintenance.

## Fork Trucks I

Module #DW0104

### Description

The module the safety considerations and general work practices of fork trucks including: Lockout/ Tagout, battery maintenance, capacitive circuits, and hydraulic system safety. This module also covers electrical systems, schematic diagrams, and diagnostic tools for fork trucks.

### Learning Objectives

- Describe safety precautions and general work practices to be followed when performing fork truck maintenance.
- Explain the function of an electric fork truck's electrical system, and describe how to use the manufacturer's documentation and schematic diagrams for troubleshooting.
- State the purpose of the diagnostic tool and its use in accessing service history, initiating service checks, and performing troubleshooting.

## Fork Trucks II

Module #DW0105

### Description

This module covers the maintenance, servicing, selection and replacement of battery systems of fork trucks. The miscellaneous electrical control components and steering and guidance systems of fork trucks. This module also covers the different hydraulic systems and break systems of fork trucks.

### Learning Objectives

- Explain the fork truck battery service requirements and change out procedure.
- Describe the operation and maintenance of miscellaneous electric system and components including contractors, operator control modules, and steering feedback systems.
- Discuss the operation and maintenance of electrical fork truck steering and guiding systems.
- Explain the operation of the electric fork truck hydraulic system.
- Describe the operation and maintenance of the electric fork truck brake system.



## Intermediate Distribution and Warehousing



### Battery Charging System I

Module #DW0201

#### Description

This module introduces you to batteries and their chargers, the charging system components, battery types, battery construction and the safety precautions associated with them. This module also covers the explosive gasses associated with batteries as well as the safety measures to be taken to contain a spill when a spill occurs.

#### Learning Objectives

- Describe battery burn hazards and how to prevent them.
- Explain battery explosive gas hazards and how to prevent them.
- Discuss battery spills and disposal of spilled liquids.

### Battery Charging System II

Module #DW0202

#### Description

This module covers the battery charging system and the maintenance required. In addition, this module covers the battery charging system components, troubleshooting techniques, and the steps necessary to recycle of the battery.

#### Learning Objectives

- Explain the process of industrial battery charging system and maintenance, including record keeping.
- Describe battery charging system components and their associated functions.
- Discuss battery charging system troubleshooting techniques.
- Describe battery recycling procedures.

### Photo-eye Installation

Module #DW0203

#### Description

This module covers the characteristics, alignment, and installation of photo-eyes.

#### Learning Objectives

- Explain photo-eye characteristics for field of view, range, and gain adjustment.
- Discuss beam alignment techniques.
- List best practices for photo-eye installation.

## Pi-Touch

Module #DW0204

### Description

This module introduces you to the Pi-Touch hand-held inventory assistant. We examine the physical components and connections, control screens, and the machine's manual operations.

- Describe the Pi-Touch's physical components.
- Identify the Pi-Touch connections and their purposes.
- Identify the manual control screen controls and functions.
- Identify the load handling device or LHD control screen controls and functions.

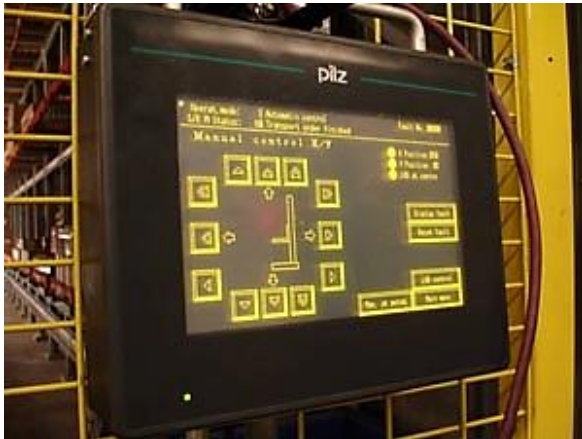

## Sorter Hardware

Module #DW0205

### Description

This module gives an overview of induction and merge conveyor equipment, the sortation conveyor equipment, power and control apparatus.

### Learning Objectives

- Describe the equipment in the induction section that provides for package accumulation and gapping.
- Discuss the components that comprise the merge conveyor.
- Describe the equipment used in the sortation conveyor.
- Describe the sorter electrical power and control components.

## Sorter Operations

Module #MDW0206

### Description

This module covers the components in the induction section, the process of scanning and the process of sortation.

### Learning Objectives

- Describe the components included in the induction section.
- Explain the package scanning process.
- Describe the package sortation process.

## Switchgears

Module #DW0207

### Description

This module covers the fundamentals of switchgear, the control and operational practices, the functions of close and trip, fault and overcurrent protective devices, and electrical bus systems.

### Learning Objectives

- Describe typical switchgear design and operational practices.
- Discuss switchgear operation and control.
- Explain electrically operated close, trip, trip-free, and anti-pump functions.
- List two types of switchgear fault and overcurrent protective devices.
- Describe electrical bus systems and use of mechanical interlocks.



## Advanced Distribution and Warehousing



### AGV Overview

Module #DW0301

#### Description

This module gives an overview of AGV, its orientation, major components, and major systems. This module also covers navigation and guidance of AGV's including the inertial navigation, the terms associated with the navigation and guidance, the magnet sensor, various magnets, and the guidance feedback system.

#### Learning Objectives

- State the purpose of an AGV.
- Recognize the major components of an AGV.
- Explain the difference between navigation and guidance.
- Explain inertial navigation.
- Discuss the Guidance Feedback System.

### AGV Operation

Module #DW0302

#### Description

This module covers the manual controls of an AGV, the manual pendant, and the steps taken to initialize the AGV. The operation modes of the AGV are also discussed, including the modes of operation and the manual dispatch mode on the AGV.

#### Learning Objectives

- Describe the function of each manual control.
- Explain how to "initialize" the AGV.
- List the operating modes.

### AGV Preventive Maintenance

Module #DW0303

#### Description

This module covers the different types of maintenance associated with an AGV, including: Daily maintenance, 200-hour maintenance, 500-hour maintenance, 1,000-hour maintenance, 2,000-hour maintenance, and shutting down the AGV. This module also gives an overview of the lift operations of an AGV and the power up of an AGV.

#### Learning Objectives

- Identify daily maintenance tasks.
- Explain the 200, 500, and 500+ hour maintenance tasks.
- Describe how to properly shut down the AGV.
- Describe the safe operation of the AGV lift.



## AGV Safety

Module #DW0304

### Description

This module covers the indications, emergency stop operation and locations, beacon and running lights, audible warning mechanism, and alarms associated with AGV safety. This module also discusses the different types of sensors such as: Door interlocks, side sensor, and pulse laser sensor. In addition, vehicle safety and an overview of the interface module are covered, as well as the VSIM and its control board.

### Learning Objectives

- Explain the operation of an emergency stop button.
- Describe the operations of the beacon strobe light and warning light.
- Explain the different audible warnings.
- Describe the operation of the pulse laser sensor.
- Explain the safety features of the vehicle safety and interface module.



## AKL Cranes

Module #DW0305

### Description

This module gives an overview of AKL cranes including the functions, glossary of terms associated with AKL cranes, operation, and axes of motion for AKL cranes. This module also discusses the components and support systems for AKL cranes as well as the modes of operation. Preventive maintenance is also covered, along with fault identification, fault types, and the most common types of faults.

### Learning Objectives

- Explain the function of the AKL crane.
- Recognize the major components of the AKL crane.
- Discuss the operation modes of the AKL crane.
- List the preventive maintenance procedures.
- Explain the fault indications and their meanings.

## ASRS Cranes

Module #DW0306

### Description

This module gives an overview of ASRS cranes, including the construction, operation and operating modes of ASRS cranes; the load storage and retrieval of these cranes as well as the ancillary equipment and applications. This module also covers the missions of ASRS cranes and necessary preventive maintenance.

### Learning Objectives

- Describe the major parts of the ASRS.
- Explain how ASRS stores and retrieves palletized loads.
- Identify ancillary material handling equipment required to process load tasks.
- Describe typical steps executed by an ASRS crane to execute a mission, including preventive maintenance.

## Barcode Scanners

Module #DW0307

### Description

This module covers the types, functions, and operating principles of barcode scanners and laser scanners. This module also covers the installation, maintenance practices, and laser safety of barcode scanners. Lastly, this module discusses the setup and programming of barcode scanners and the networks associated with barcode scanners.

### Learning Objectives

- Describe barcode scanner functions.
- Explain basic barcode scanner operating principles.
- List barcode scanner installation and maintenance practices.
- Describe a barcode setup and programming process.

## SAFETY SERIES

“COMMITTED TO  
HEALTH & SAFETY”



The modules in the *Safety* subject area begin by providing an overview of common industrial facility hazards and protective systems, including the areas of a facility where these hazards may be encountered.

These modules also introduce fire and electrical safety practices, as well as discuss topics such as hazardous communications, lockout/tagout, industrial signage, and personal protective equipment.

This series consists of 34 modules. Each module takes about 30 minutes to complete at an average pace.



### Industrial Facility Safety

Module #SAF0101

#### Description

More than 4,000 fatal, and 3 million nonfatal, work-related injuries were reported in the US in 2010. Identifying and understanding industrial hazards helps lower worker risk as well as increase facility safety and efficiency.

#### Learning Objectives

- Describe common hazards encountered in industrial facilities.
- Explain the dangers associated with electrical current and voltage.
- Describe the common industrial systems installed for personnel and equipment protection.

### Electrical Safety

Module #SAF0102

#### Description

Roughly 20% of the electricity produced in the United States every year is used to power industrial facilities and equipment. While electricity makes it possible for these facilities to operate, it also poses a very real hazard, with several hundred electricity-related fatalities occurring at the workplace every year. To avoid or treat electrical shock, one must first understand it.

#### Learning Objectives

- Define electrical shock and arc flash.
- Identify emergency response actions to take in the event of an electrical shock.
- Explain electrical safeguarding.
- Identify personal protective equipment required when working on energized electrical equipment.
- List the steps required to ensure electrical equipment is de-energized.

## Personal Protective Equipment

Module #SAF0103

### Description

The *Occupational Safety and Health Administration*, or OSHA, mandates that it is an employer's duty to provide a personal protective equipment, or PPE, program designed for their workplace. The employee must follow the PPE program and use the PPE required to conform to safe work practices for their particular job. In 2003, the Bureau of Labor Statistics reported 4.4 million non-fatal injuries in private industries; this emphasizes the importance of safety in the workplace.

### Learning Objectives

- Describe personal responsibilities regarding personal protective equipment.
- List the personal protective equipment that is commonly associated with industrial sites.
- Describe the proper care, use, and inspection of personal protective equipment.
- Explain the effects of using defective or incorrect personal protective equipment.

## Fire Safety

Module #SAF0104

### Description

This module covers different types of fires, fire prevention techniques, and fire extinguishing systems.

### Learning Objectives

- Explain the fire tetrahedron.
- Describe the five classes of fire in various industries.
- Explain various fire prevention techniques.
- Explain the ways to extinguish fires.

## Industrial Signage

Module #SAF0105

### Description

This module provides an overview of the common signage found in an industrial facility. Topics covered include how to interpret common signs in an industrial facility, the color code for labels used to identify hazards, and the OSHA color code for floor markings.

### Learning Objectives

- Identify the meanings of signs commonly found in industrial facilities.
- Explain the color code for labels used to identify hazards.
- Describe the code for industrial floor markings.

## Lockout/Tagout

Module #SAF0106

### Description

The purpose of a lockout/tagout program is to establish procedures for placing lockout and/or tagout devices on energy-isolating components. Following these procedures ensures that equipment is de-energized and unexpected startup and/or release of stored energy is prevented. Injuries to personnel during equipment servicing and maintenance are greatly reduced with a properly implemented lockout/tagout program.

### Learning Objectives

- State the purpose of a lockout/tagout program.
- List the principles of a lockout/tagout program.
- Identify lockout/tagout devices.
- Explain the responsibilities of the authorized employee.

## Hazardous Communications

Module #SAF0107

### Description

This module gives an overview on how an effective hazardous communication program can prevent injuries in a work environment.

### Learning Objectives

- Explain the importance of hazardous communication.
- Describe the labeling requirements for hazardous communication, including material safety data sheets.
- Discuss the proper use of hazardous communication programs.



## Environmental Awareness

Module #SAF0108

### Description

Since the Industrial Revolution in the last century, the public has become more concerned about preserving the environment and exploring the benefits of sustainability. Environmental awareness has had a major impact on industry worldwide. It has led to greater scrutiny of all industrial processes because they contribute the largest amount of environmental pollution.

The U.S. *Environmental Protection Agency*, or EPA, reported in its *Toxics Release Inventory*, or TRI, that industrial facilities release more than 6.5 billion pounds of toxic chemicals into the environment each year. Of these 6.5 billion pounds, 100 million pounds contain cancer-causing agents. Environmental issues, such as pollution, resource depletion, climate change, and waste management, have forced industry to change processes as a means of reducing its environmental impacts.

### Learning Objectives

- Discuss the impact of environmental issues on industry.
- Describe environmental, health, and safety regulations.
- Identify priority pollutants in plant environments.
- Identify actions that minimize pollution.

## Hazardous Materials

Module #SAF0109

### Description

This module explains how to identify common hazardous materials, describe hazardous material handling and disposal procedures, and discuss hazardous material safety precautions and regulations.

### Learning Objectives

- Identify common hazardous materials.
- Describe handling and disposal procedures.
- Discuss safety precautions and regulations.

## Benzene Awareness

Module #SAF0110

### Description

This module covers the awareness training of benzene and will answer questions such as: What is benzene? What are the health risks? Who is at risk for exposure? This module will also discuss the OSHA regulatory limits, personal protective equipment, and emergency procedures associated with benzene.

### Learning Objectives

- Describe the physical properties of benzene.
- State the health risks associated with benzene exposure.
- Identify possible operations that can result in benzene exposure in an industrial environment.
- State the permissible exposure limits for benzene.
- List the PPE required for environments that may have potential benzene exposure.

## Hydrogen Sulfide Awareness

Module #SAF0111

### Description

In *Hydrogen Sulfide Awareness* training, you will learn about the properties of hydrogen sulfide and the associated health risks. You will also learn about the proper precautions to take to minimize exposure to hydrogen sulfide.

- State the properties of hydrogen sulfide.
- Describe the health risks associated with hydrogen sulfide exposure.
- Explain the methods to minimize exposure to hydrogen sulfide.
- Identify the PPE required to work in areas with various concentration levels of hydrogen sulfide.

### Learning Objectives

- State the properties of hydrogen sulfide.
- Describe the health risks associated with hydrogen sulfide exposure.
- Explain the methods to minimize exposure to hydrogen sulfide.
- Identify the PPE required to work in areas with various concentration levels of hydrogen sulfide.

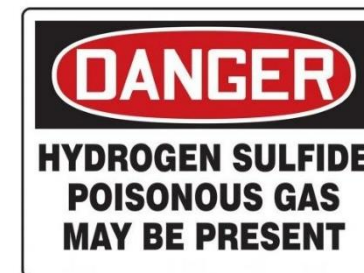

## Confined Space Entry Awareness Level

Module #SAF0112

### Description

A *confined space* is defined as “any situation where a person's head or body crosses the plane of an opening that meets any of the following criteria:

- Limited opening for entry or exit
- Unfavorable natural ventilation that could contain or produce flammable toxic, or oxygen deficient atmospheres
- Spaces or areas not intended or designed for continuous personnel occupancy.”

### Learning Objectives

- Define a “confined space.”
- Describe several safety hazards associated with confined spaces.
- Describe several safety precautions for entering a confined space.



## HAZWOPER Awareness

Module #SAF0113

### Description

The principal reason *Hazardous Waste Operations and Emergency Response* (HAZWOPER) exists is to provide fundamental training in hazardous waste procedures so that all emergency workers are coordinated and working with the same set of rules of engagement. HAZWOPER is the starting point for any emergency responder who is likely to come across nuclear, biological, or chemical (NBC) waste. Police and fire personnel, emergency medical responders, environmental response personnel, military, FEMA, Department of Health, incident commanders, and hazardous materials remediators all learn the fundamentals in a HAZWOPER course.

### Learning Objectives

- Define the term HAZWOPER.
- State the company policy concerning HAZWOPER.
- State the requirements for contractor access to the client's written safety and health plan.
- Describe the process used for a Hazardous Material cleanup.
- List the required subject areas of a written safety and health program.

## First Aid I

Module #SAF0114

### Description

This module provides guidance for effective responses and treatment related to external bleeding, burns, and nervous system injuries. Topics covered include OSHA-compliant First Aid kits and how an injured person should be evaluated. In addition, the module provides an overview of how to control external bleeding, the treatment of minor burns, and how to care for head, neck, and spinal injuries.

### Learning Objectives

- Describe OSHA-compliant first aid kits.
- Explain the evaluation of an injured or ill person.
- List methods used to control external bleeding.
- Explain the treatment of minor burns.
- Describe how to care for head, neck, and spinal injuries.

## First Aid II

Module #SAF0115

### Description

This module provides an overview of basic first aid care, including actions to take when poisoning is suspected or someone is choking. The module also explains how to perform CPR, the procedures for operating an AED device, and how to identify the symptoms of a stroke.

### Learning Objectives

- Describe the actions to take when poisoning is suspected.
- List the steps for treating a choking victim.
- Explain how to perform CPR.
- Discuss the operating procedures for an AED device.
- List the symptoms of a stroke.



## Bloodborne Pathogens

Module #SAF0116

### Description

Bloodborne pathogens means pathogenic microorganisms that are present in human blood and can cause disease. These pathogens include, but are not limited to, hepatitis B virus (HBV), which causes hepatitis B, hepatitis C virus (HCV), which causes hepatitis C, human immunodeficiency virus (HIV), which causes AIDS, and other pathogens, such as those that cause malaria.

About 5.6 million workers in healthcare and other facilities are at risk of exposure to bloodborne pathogens such as HBV, HCV, and HIV. Bloodborne pathogen exposure may occur in many ways, but needlestick injuries are the most common cause. Exposure may also occur through contact of contaminants with the nose, mouth, eyes, or skin.

### Learning Objectives

- Give at least three examples of workers who are at risk of exposure to bloodborne pathogens.
- List the three ways exposure to bloodborne pathogens commonly occur.
- Describe at least five key aspects of a Bloodborne Pathogen Exposure Control Plan.
- Explain how properly used PPE and appropriate housekeeping methods protect against exposure to bloodborne pathogens.
- List three important steps to take if exposed to a bloodborne pathogen.

## Crane Safety

Module #SAF0117

### Description

Cranes pose significant safety issues, both for the operators and workers in proximity to them. Moving large, heavy loads is crucial to today's manufacturing and construction industries, and several technologies have been developed for these operations. The *American National Standards Institute*, or ANSI, and the *American Society of Mechanical Engineers*, or ASME, continually update standards for crane manufacturing, operational procedures, inspection requirements, and operator qualifications. In addition, the *Specialized Carriers and Rigging Association*, or SC&RA, which represents most of the crane owners and users, has developed a set of requirements for crane operator qualifications and certification.

### Learning Objectives

- List the four major causes of crane accidents.
- Describe the pre-planning that is required before putting a crane in use.
- State the main precautions that apply to working with cranes near power lines.

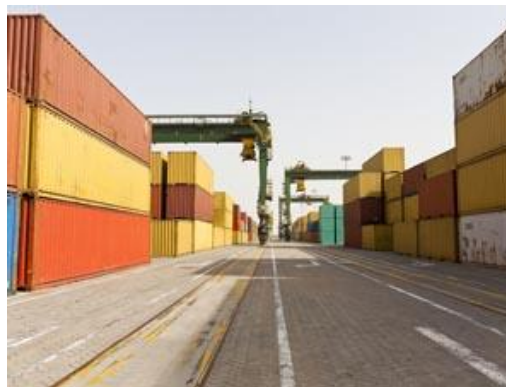

## Exit Routes, Emergency Action, and Fire Prevention Plans

Module #SAF0118

### Description

There is a long and tragic history of workplace fires in this country caused by problems with fire exits and extinguishing systems.

OSHA requires employers to provide proper exits, firefighting equipment, and employee training to prevent fire related deaths and injuries in the workplace.

Emphasis is on escaping from fires; however, some additional hazards include explosions, earthquakes, bomb threats, toxic vapors, and storms (tornadoes, hurricanes, etc.). Compounding factors that may interfere with a safe escape include panic and confusion, poor visibility, lack of information, and misinformation. These factors frequently cause more injuries and fatalities than the hazard itself.

### Learning Objectives

- List or describe the three parts to an appropriate exit route.
- Discuss at least four characteristics of an effective exit route.
- Give four reasons for developing an emergency action plan.
- Name the required elements of a fire prevention plan.
- List the five classes of fire extinguishers and the types of fires they can properly extinguish.
- Describe at least four requirements for proper maintenance of portable fire extinguishers.

## Fall Protection

Module #SAF0119

### Description

Occupational fatalities caused by falls remain a serious public health problem throughout the United States. Data collected by the Bureau of Labor Statistics (BLS) Census of Fatal Occupational Injuries indicates that falls are one of the leading causes of traumatic death in the workplace, accounting for 13.7% of such deaths (808 of 5,900) in 2001. During that year, 23 workers died in falls through skylights, 11 died in falls through existing roof openings, and 24 died in falls through existing floor openings.

Data from the BLS Survey of Occupational Injuries and Illnesses shows that, during 1999, nearly 300,000 workers in private industry sustained injuries from falls, resulting in lost time from work. In 1999, an estimated 80 workers were injured in falls through skylights, 100 in falls through existing roof openings, and 617 in falls through existing floor openings. Most injuries occurred in construction, though many injuries occurred in other industries such as manufacturing, retail trade, and services.

### Learning Objectives

- Identify the working conditions that prompt the use of fall protection.
- Explain the options that are available to protect workers from falls.
- List at least four methods of fall protection available for protecting workers.
- State the main criteria that prompts use of fall protection for construction workers.

## Machine Guarding

Module #SAF0120

### Description

Crushed hands and arms, severed fingers, blindness—the list of possible machinery-related injuries is as long as it is horrifying. Safeguards are essential for protecting workers from needless and preventable injuries. A good rule to remember is: Any machine part, function, or process that may cause injury must be safeguarded. Where the operation of a machine can injure the operator or other workers, the hazard must be controlled or eliminated.

### Learning Objectives

- Describe at least two of the main causes of machine accidents.
- List three requirements for safeguards.
- List five machinery parts that pose hazards when unguarded or improperly guarded.
- List at least five types of machine guards.
- List at least three types of devices used to safeguard machines.
- Describe a situation that warrants machine guarding and an appropriate method of guarding the machine or part to prevent injury or accident.



## Materials Handling

Module #SAF0121

### Description

The efficient handling and storing of materials is vital to industry. These operations provide continuous flow of raw materials, parts, and assemblies through the workplace, and ensure that materials are available when needed. Yet, the improper handling and storing of materials can cause costly injuries. Some of the most common causes of material handling injuries are:

- Improper manual lifting or carrying loads that are too large or heavy.
- Being struck by materials or being caught in pinch points.
- Crushed by machines, falling materials or improperly stored materials.
- Incorrectly cutting ties or securing devices.

### Learning Objectives

- List the three main injuries that occur during material handling, storage, use, and disposal.
- Describe at least two ways to prevent injury when performing manual lifting.
- Know the hazards involved in mechanical material handling.
- Understand the training required in materials handling.
- Describe at least three actions that can reduce or eliminate hazards when storing or disposing of materials.

## Safety and Health Programs

Module #SAF0122

### Description

Effective management of worker safety and health protection is a decisive factor in reducing the extent and the severity of work-related injuries and illnesses. A good safety and health program addresses all work-related hazards, including those potential hazards that could result from a change in worksite conditions or practices.

OSHA's experience in the *Voluntary Protection Program* has also indicated that effective management of safety and health protection improves employee morale and productivity, as well as significantly reducing Workers Compensation costs and other less obvious costs of work-related injuries and illnesses.

### Learning Objectives

- Discuss the benefits of an effective safety and health program.
- List the four elements of an effective safety and health program.
- Describe the three methods to prevent and control workplace hazards.
- Describe worksite analysis.
- Discuss safety and health training needs.



## Walking and Working Surfaces

Module #SAF0123

### Description

Slips, trips, and falls cause the majority of general industry accidents. 15% of all accidental deaths are caused by slips, trips, and falls. These cause more fatalities than any other accident except motor vehicles. The OSHA standards for walking and working surfaces apply to all permanent places of employment, except where domestic, mining, or agricultural work is performed. Falls from as little as 4 to 6 feet can cause serious lost-time accidents and sometimes death. The OSHA standard identifies areas or activities where fall protection is needed. The standard clarifies how an employer must provide fall protection for employees, such as identifying and evaluating fall hazards and providing training. Under the standard, employers are able to select fall protection measures compatible with the type of work being performed.

The most cited areas of this module, *Walking and Working Surfaces*, are found in housekeeping requirements, and requirements for guarding floor openings and wall openings. Poor housekeeping and failure to properly guard wall and floor openings results in slips, trips, and falls.

### Learning Objectives

- Explain the requirements for guarding floor openings and wall openings.
- Explain the requirements for guarding roof openings and skylights.
- Describe the requirements for stairways, ladder ways and railings.
- Follow recommended practices for using stairs and ladders.
- Follow recommended practices for using scaffolding and other working surfaces.

## Asbestos

Module #SAF0124

### Description

*Asbestos* is the name for a group of naturally occurring minerals that separate into strong, very fine fibers. The fibers are heat-resistant and extremely durable. Because of these qualities, asbestos has become very useful in construction and industry.

Asbestos tends to break down into a dust of microscopic fibers. Because of their size and shape, these tiny fibers remain suspended in the air for long periods of time and can easily penetrate body tissues after being inhaled or ingested. Due to its durability, these fibers can remain in the body for many years and, thereby, become the cause of asbestos-related diseases. Symptoms of these diseases generally do not appear for 10 to 30 years after the exposure. Unfortunately, long before its effects are detectable, asbestos-related injury to the body may have already occurred. There is no safe level of exposure known; therefore, exposure to friable asbestos should be avoided.

### Learning Objectives

- Explain the dangers of asbestos exposure.
- Describe how workers are protected and can protect themselves from asbestos hazards.
- Describe how building owners and managers are required to manage asbestos.

## Back Safety Ergonomics

Module #SAF0125

### Description

Although back injuries account for no work-related deaths, they do account for a significant amount of human suffering, loss of productivity, and economic burden on compensation systems. Back disorders are one of the leading causes of disability for people in their working years and afflict over 600,000 employees each year. The frequency and economic impact of back injuries and disorders on the workforce are expected to increase over the next several decades as the average age of the workforce increases and medical costs go up.

### Learning Objectives

- Explain the importance of back safety.
- Describe how to prevent injuries and reporting requirements in the workplace.
- Identify ergonomic issues in the workplace.
- Understand the ergonomic solutions to control hazards.
- Explain the importance of ergonomics training and enforcement.

## GHS

Module #SAF0126

### Description

The GHS is an acronym for the *Globally Harmonized System of Classification and Labeling of Chemicals*. The GHS is a system for standardizing and coordinating the classification and labelling of chemicals. The GHS itself is not a regulation or a standard. The GHS establishes agreed hazard classification and communication provisions with explanatory information on how to apply the system. The elements in the GHS supply a mechanism to meet the basic requirement of any hazard communication system, which decides if the chemical product produced and/or supplied is hazardous and prepares a label and/or Safety Data Sheet as appropriate.

### Learning Objectives

- Recognize the importance of the GHS.
- Define health, physical, and environmental hazards of chemicals.
- Communicate hazard information, as well as protective measures, on labels and Safety Data Sheets.
- Identify the PPE required to work in areas with various concentration levels of hydrogen sulfide.



## Lead Overview for General Industry

Module #SAF0127

### Description

Inorganic lead is a malleable, blue-gray, heavy metal that occurs naturally in the Earth's crust. Lead was one of the first metals used by humans and, consequently, the cause of the first recorded occupational disease.

### Learning Objectives

- Describe the dangers of lead exposure.
- Explain the effects of lead exposure.
- Describe the hazards of lead-based paint and how it is regulated.
- Recognize how workers are protected and can protect themselves from lead hazards.

## Lead Overview for Base Construction

Module #SAF0128

### Description

Inorganic lead is a malleable, blue-gray, heavy metal that occurs naturally in the Earth's crust. Lead was one of the first metals used by humans and, consequently, the cause of the first recorded occupational disease.

### Learning Objectives

- Describe the dangers of lead exposure.
- Explain the effects of lead exposure.
- Identify Lead-Based Paint Hazards and Regulations.
- Describe the hazards of lead-based paint and how it is regulated.
- Recognize how workers are protected and can protect themselves from lead hazards.

## Toxic Substance Control Act Module #SAF0129

### Description

The *Toxic Substances Control Act (TSCA)* of 1976 provides the EPA with authority to require reporting, recordkeeping and testing requirements, and restrictions relating to chemical substances and/or mixtures. Certain substances are generally excluded from the TSCA, including, among others, food, drugs, cosmetics and pesticides.

The TSCA addresses the production, importation, use, and disposal of specific chemicals including polychlorinated biphenyls (PCBs), asbestos, radon, and lead-based paint.

### Learning Objectives

- Describe the basics of the *Toxic Substances Control Act*.
- Explain how to comply with the *Toxic Substances Control Act*.
- Describe how toxic substances are safely monitored.
- Discuss the appropriate cleanup actions in the event of a contamination.



## Worker Safety Documents and the Qualified Electrical Worker Module #SAF0130

### Description

A good electrical safety program uses a systematic approach in the development of the rules and procedures to provide the best possible safety environment for all workers.

### Learning Objectives

- Name the document used to enforce worker safety.
- Name the organization providing reference documents for electrical safety.
- List the equipment requirements for an effective electrical safety program.
- Identify the qualifying authority for an electrical worker.
- List the training requirements for a qualified electrical worker.

## Electrical Hazards and the Electrical Safety Program Module #SAF0131

### Description

Electricity is all around and many of us would not be able to perform most of our day-to-day tasks without it. Electricity cannot be treated without respect, and this is especially true for the individuals who are required to perform maintenance on electrical equipment. An understanding of what an electrical hazard is and what is in a good electrical safety program will help the electrical worker stay safe.

### Learning Objectives

- Define an “electrical hazard.”
- Define electrical safety.
- List the four key elements of an electrical safety program.
- Name five subjects contained in an electrical safety program procedure.
- State the two primary hazards associated with electricity.

## Electrical Work, Safe Work Area, and Other Precautions Module #SAF0132

### Description

Electrical work is inherently dangerous, and not just for the qualified individual performing the maintenance activity. Measures must be taken to prevent the unqualified individual from being exposed to an electrical hazard. Understanding what electrical work is and the methods that may be used to alert the unqualified individual will greatly enhance safety in the workplace.

### Learning Objectives

- Define “electrical work.”
- Describe the two categories of electrical work.
- State the purpose of a live/dead/live check.
- Name the various warning methods.
- Explain additional precautions when performing electrical work.



## **PPE Other Equipment and Shock Rescue**

Module #SAF0133

### **Description**

The best method to control a hazard in the workplace is to eliminate the hazard. Hazards may be eliminated by changing the process, changing the work methods, or by an engineering change that eliminates the hazard. Electrical hazards are the most difficult to eliminate, the vast majority of industrial process could not be performed with electrical systems below the electrical hazard level of 50 volts AC or DC. The final protective measure that must be employed is Personal Protective Equipment (PPE) and careful selection of the tools and equipment used to perform electrical work.

### **Learning Objectives**

- State the caloric value of the four PPE categories.
- List the classes of insulating and shielding materials.
- Describe the pre-use inspection for insulating rubber gloves.
- Identify the re-test requirements for insulating rubber gloves.
- State the purpose of test equipment categories.
- Name the preferred method to remove a shock victim from an energized circuit.

## **Spill Prevention, Control, and Countermeasures**

Module #SAF0134

### **Description**

Oil spills endanger public health, impact drinking water, devastate natural resources, and disrupt the economy. During storage, transport, or as the result of energy exploration and production activities, oil and other oil-based products are sometimes spilled onto land or into waterways. When this occurs, human health and environmental quality are put at risk. Every effort must be made to prevent oil spills and to clean them up promptly once they occur.

### **Learning Objectives**

- Explain spill prevention, control, and countermeasure plans.
- Describe elements of a facility response plan.
- Identify the regulations required for spill prevention.
- Explain the concepts of spill containment.
- Describe what to do in the event of a spill.